

# Hand Tools

Item	Page
Bricklaying	45-46
Drywalling	47-48
Hammers & Mallets	49-50
Levels	51-52
Line Marking	53
Roofing	54
Decorating	55-56
Adhesives & Tapes	57
Boltcutters	58
Clamps, Cramps & Vices	59-60
Knives & Blades	61-62
Marking Out	63
Stapling	64
Pliers	65-66
Screwdrivers	67-68
Tapes, Rules & Measuring	69-70
Tool Handling & Storage	71-72
Plumbing	73-74
Tiling	75-76
Chain & Rope	77
Electrical Equipment	78
Groundworking Tools	79-80
Ladders	81-82
Lighting	83-84
Padlocks	85
Site Safety	86
Safety Products	87-88
Woodworking Tools	89-90
Saws	91-93

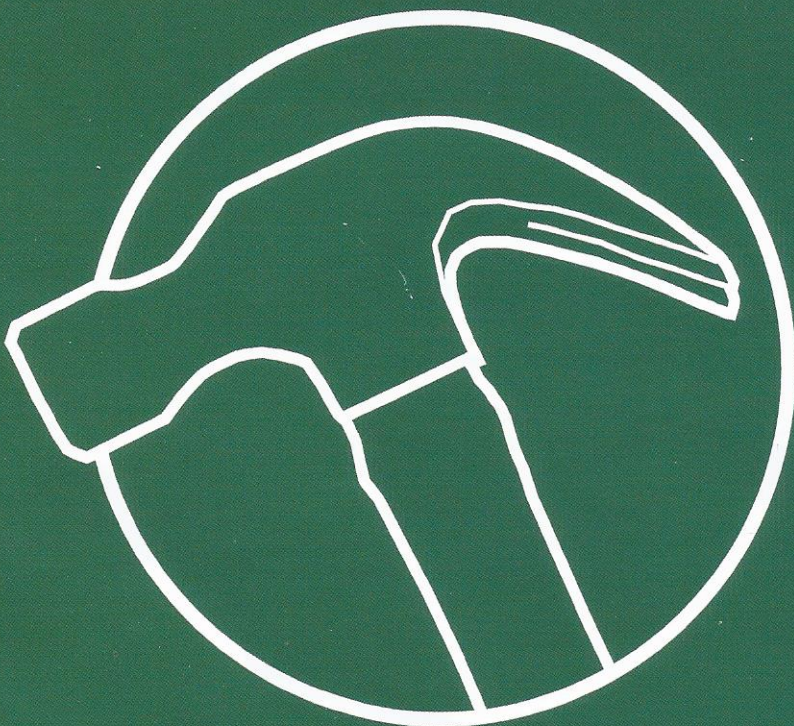

## Marshalltown Brick Trowel

### Philadelphia Pattern

<b>M1910D</b>	10"	£41.98
<b>M19105D</b>	10.1/2"	£41.98
<b>M1911D</b>	11"	£41.98
<b>M1912D</b>	12"	£41.98

### London Pattern

<b>M3411D</b>	11"	£41.98
<b>M3412D</b>	12"	£30.55

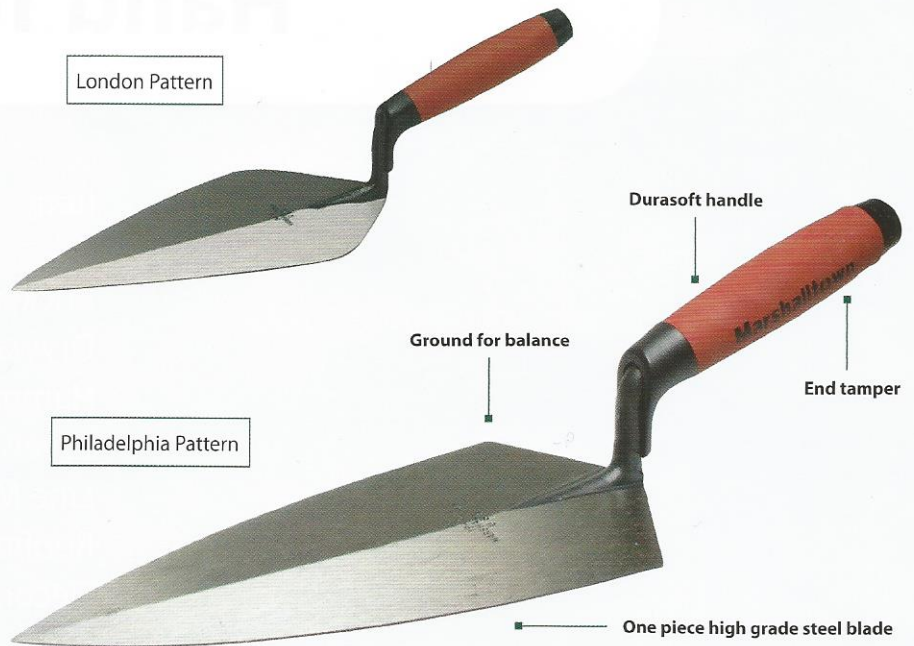

## Hardman Brick Trowel

### Philadelphia Pattern

**AT10020** 11" £6.86

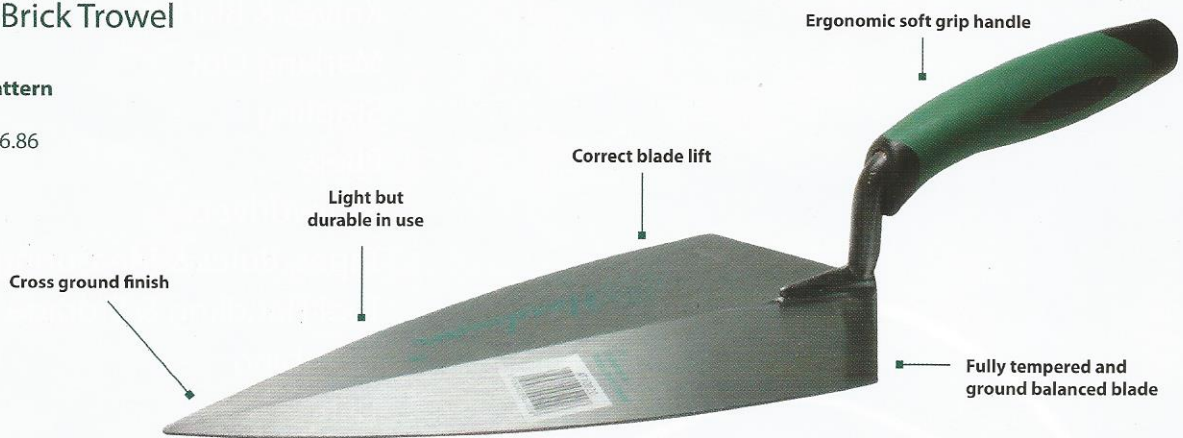

## Marshalltown Pointing Trowel

### Philadelphia Pattern

<b>M4545D</b>	4" x 2.1/4"	£14.34
<b>M455D</b>	5" x 2.1/4"	£14.34
<b>M456D</b>	6" x 2.3/4"	£14.34
<b>M457D</b>	7" x 3"	£14.34

- Durasoft handle
- Ground and polished



## Hardman Pointing Trowel

### Philadelphia Pattern

<b>AT10025</b>	5"	£3.80
<b>AT10026</b>	6"	£3.93

- Designed for hard-wearing performance
- Innovative comfort grip handle





**1. Marshalltown Gauging Trowel M48D** £25.66  
 • Durasoft handle  
 • Round end blade - for smaller mixing and filling

**2. Hardman Gauging Trowel AT10030** £3.83  
 • Comfort grip  
 • Round blade tip  
 • Designed for hardwearing performance

**3. Hardman Flooring Trowel AT10015** 16" £10.51  
 • For smoothing concrete, drives and paths

**4. Hardman Bucket Trowel AT10060** 7" £6.86  
 • Comfort grip  
 • Stainless steel blade  
 • Ideal for bucket mixing

**5. Hardman Window / Margin Trowel**  
**AT10063** 1/2" £2.13  
**AT10064** 5/8" £2.31  
**AT10065** 3/4" £2.50  
**AT10066** 1" £2.69  
 • Ideal for cement edging

**6. Hardman Joint Raker AT10067** £6.53  
 • Removes mortar before pointing

**7. Marshalltown Brick Jointers**  
**M80** 1/2 x 5/8" £5.96  
**M81** 3/4 x 7/8" £5.96  
**M82** 5/8 x 3/4" £5.96  
**M83** 3/8 x 1/2" £5.96  
 • Hardened blade  
 • Double ended for concave jointing in brickwork

**8. Marshalltown Brick Tongs M88** £22.64  
 • Adjustable, can carry 6-10 bricks

**9. 3 Gallon Builders Bucket**  
**BLACK** £1.41  
**YELLOW** £2.55  
 • Heavy duty c/w pouring lip

**10. Tubtrugs Flexible Tubs**  
**TUB14** 14LTR £2.99  
**TUB26** 26LTR £3.99  
**TUB40** 40LTR £4.99  
**TUB75** 75LTR £9.99  
 • General purpose tubs  
 • Super flexible, durable, UV and frost resistant with strong 'CE' tested handles

**11. Tubtrugs Shallow Flexible Tub 35LTR** £8.99  
 • General purpose tubs  
 • Ideal for bricklayer's spot and tool cleaning

**12. Scutch Holder Chisels**  
**AT28050** 1" £7.38  
**AT28051** 1.1/2" £8.27  
 • Use in conjunction with scutch combs to dress stone

**13. Hardman Cold Chisels**  
**Sizes 1/4" x 4" - 1" x 24"**  
 • Premium quality for general cutting of metals & stonework

**14. Hardman Bolster Chisels**  
 \* c/w hand guard  
**Electricians Bolsters**  
**AT28040** 2.1/4" £4.09  
**AT28035** 2.1/4" £6.88\*  
**Brick Bolsters**  
**AT28041** 3" £5.34  
**AT28025** 3" £8.18\*  
**AT28042** 4" £6.29  
**AT28026** 4" £8.20\*  
 • Forged from cast carbon steel  
 • Designed for cutting brick, stone and paving  
 • Hand guard for safety & comfort  
 • Complies with BS 3066 standard

Also available - please ask...



Corner Blocks



Line Pins

Brands featured here...



## Marshalltown Permashape

<b>MPB145D</b>	14" x 4"	£42.57
<b>MPB205D</b>	20" x 5"	£51.54
<b>MPB145SD</b>	14" x 5"	£55.10

<b>MPB815</b>	18" x 4"	£49.25
<b>MPB13SSD</b>	13" x 5"	£52.68

### PERMASHAPE - THE FACTS

- Broken in-shape eliminates line & ripple marks right from the start
- Bevelled work edges prevent surface aggregate popping
- Guaranteed to maintain original broken-in shape
- Aluminium alloy Xtralite mounting is lightweight but very strong
- Resilient Durasoft handle provides a soft feel, reduces fatigue and offers excellent durability

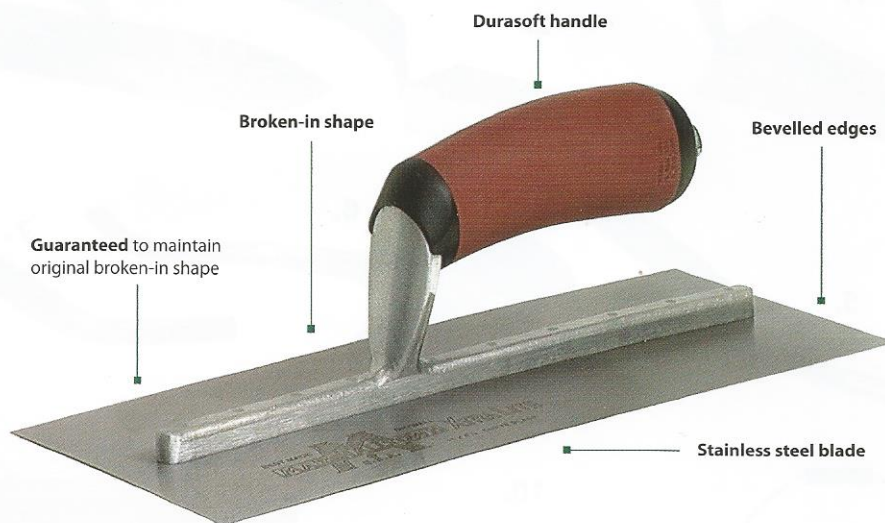

## Marshalltown Steel

<b>MXS1D</b>	11" x 4.1/2"	£35.01
<b>MXS13D</b>	13" x 5"	£36.58
<b>MXS73D</b>	14"	£37.69
<b>MXS77D</b>	18" x 4.1/2"	£35.98

- Also available in stainless steel

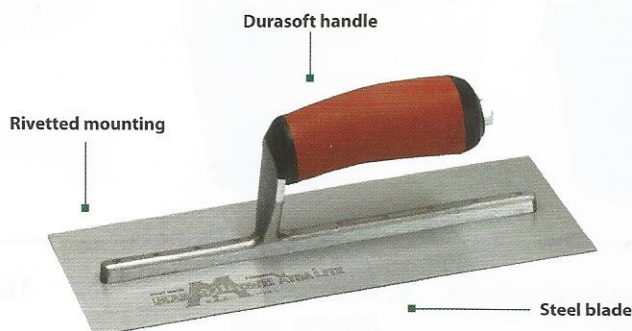

## Marshalltown Aluminium Hawk

<b>M1D</b>	13" x 13"	£23.76
<b>M2</b>	13.1/2" x 13.1/2"	£24.79

- Durasoft handle

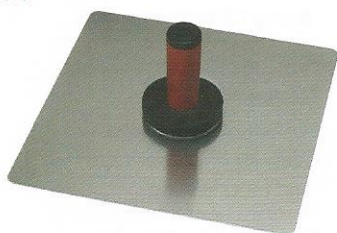

## Marshalltown Swivel Pole Sander

<b>M26 Sander</b>	£16.08
<b>M28 Sander Pole 48"</b>	£7.46

- For walls and ceilings



## Hardman Finishing Trowel

<b>AT10001</b>	11" x 4.1/2"	£8.76
<b>AT10002</b>	14" x 4.3/4"	£9.05
<b>AT10005</b>	11" x 4.1/2"	£9.91

Stainless Steel



## Hardman Polyurethane Floats

<b>AT10046</b>	11 x 28cm	£5.17
<b>AT10047</b>	15 x 35cm	£5.77

- For concrete rendering





**1. Estwing Drywall Hammer**  
**E311** £47.48  
 • Crowned & Scored face  
 • Shock resistant grip

**2. Stanley Anti-Vibe Drywall Hammer**  
**1-54-015** £21.91  
 • Patented anti-vibe technology  
 • Offset striking face

**3. Marshalltown External Corner Trowel**  
**M25D** £15.00  
 • Durasoft handle  
 • Stainless blade

**4. Hardman External Corner Trowel**  
**AT10062** £3.86  
 • Stainless steel blade  
 • 120mm x 97mm x 97mm

**5. Marshalltown Internal Corner Trowel**  
**M23D** 4 x 5 £14.32  
**M24D** 5 x 3.1/2 £13.00  
 • Durasoft handle  
 • Stainless blade

**6. Hardman Internal Corner Trowel**  
**AT10061** £3.86  
 • Stainless steel blade  
 • 120mm x 97mm x 97mm

**7. Marshalltown Skywalker Stilts**  
**MSW18** 18-30" Lift £233.39  
 • Makes plastering and ceiling work simple

**8. Benson Mixing Tubs**  
**25L** £7.40  
**40L** £10.93  
**65L** £12.02  
 • Polyethylene with moulded handles

**9. Benson Plasterers Bath**  
**PB1** 50 x 25 x 13" £32.06  
 • Durable polyethylene construction

**10. Benson Power Whisk**  
**PW2-5** £9.99  
**PW3-** £7.70  
 • Suitable for mixing plaster, mortar, paint and adhesives  
 • Manufactured in carbon steel, zinc plated for rust protection  
 • Designed to fit into a 3/8" drill chuck  
 • PW2 featured here

**11. Hardman Jab Saw**  
**AT35004** £4.65  
 • Triple ground hardened teeth  
 • Two way cutting  
 • Fast cut

**12. Benson Aluminium Derby**  
**D3-4** £24.43  
 • Aluminium section with adjustable hardened handles

**13. Hardman Plasterers Feather Edge**  
**AT57039** 6" £30.76  
**AT57040** 8" £39.28  
**AT57041** 10" £54.75  
 • Lightweight extruded aluminium  
 • For tamping & smoothing plaster concrete

**14. Wiss Snips**  
**M1-R** Left hand £24.45  
**M2-R** Right hand £24.45  
**M3-R** Straight £24.45  
 • For ease of cutting thin gauge sheets  
 • Red, green and yellow handles available  
 • Non-slip serrated jaws, made of extra tough, wear-resistant molybdenum steel

Also available - please ask...



Scarifier



Tapping Knife 8"/10"/12"

Brands featured here...

Estwing



Hardman  
 WORK TOUGH TOOLS

Wiss

### Estwing Vinyl Grip Claw Hammer

<b>E3-16C</b>	16oz	£35.02
<b>E3-20C</b>	20oz	£40.32
<b>E3-28C</b>	24oz	£48.32

Made in the USA

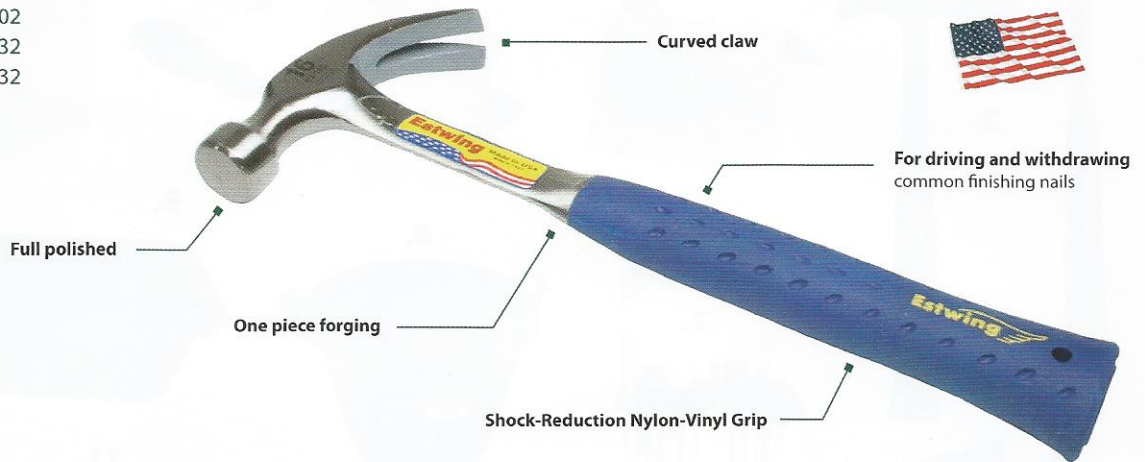

### Stanley Fatmax Anti-Vibe Hammer

<b>1-51-742</b>	Rip Claw	16oz	£27.92
<b>1-51-944</b>	Rip Claw	20oz	£22.59
<b>1-51-941</b>	Curved Claw	16oz	£20.43
<b>1-51-943</b>	Curved Claw	20oz	£22.29

100% crack detection inspection to ensure quality and performance



### Hardman All Steel Claw Hammer

<b>AT20007</b>	16oz	£12.21
<b>AT20008</b>	20oz	£13.27
<b>AT20010</b>	24oz	£17.31

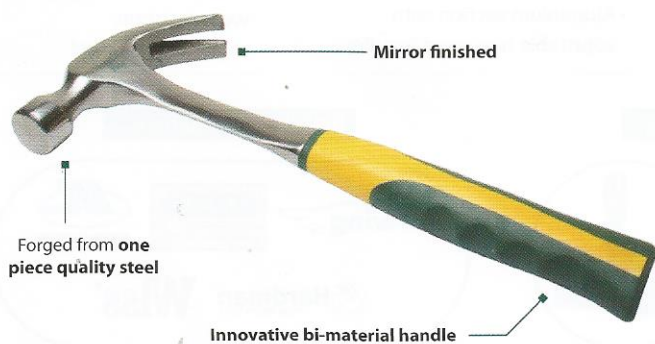

### Hardman Claw Hammer

<b>AT20002</b>	Fibreglass Shaft	16oz	£5.60
<b>AT20003</b>	Fibreglass Shaft	20oz	£6.29

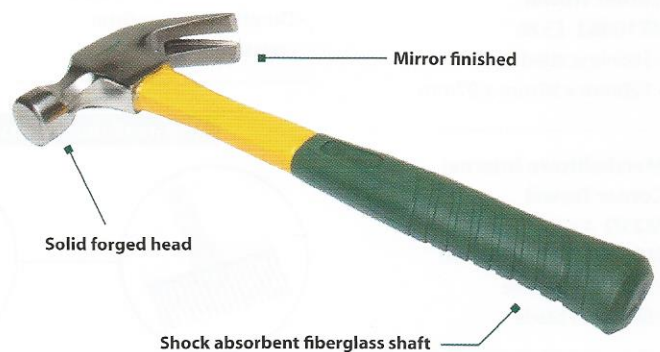



**1. Estwing Weight Forward Hammer**

**EWF21** 21oz smooth face  
£48.79

- Revolutionary design for maximum power and weight
- Full polished
- Reduces shock by up to 50%

**2. Stanley Blue Strike Claw Hammer**

**1-51-488** 16oz £9.75  
**1-51-489** 20oz £10.67

- Tubular steel oval shaft
- Flock filled vinyl grip impervious to heat, oil and most solvents

**3. Hardman Club Hammers**

*Hickory Shaft*  
**AT20014** 2.1/2lb £4.71  
**AT20015** 4lb £9.52

*Fibreglass Shaft*  
**AT20011** 2.1/2lb £6.35  
**AT20012** 4lb £8.83

- Ground striking faces

**4. Thor Rubber Mallets**

**952** 325g (54 x 90mm) £4.44  
**953** 525g (64 x 113mm) £5.52  
**954** 750g (74 x 127mm) £7.46  
**957** 1125g (90 x 139mm) £11.76

- Ideal for woodworking, builders, window frame makers, shop fitting, car trim, DIY etc
- Also available in white

**5. Thor Nylon Hammers**

**708** 25mm face £8.30  
**710** 32mm face £9.59  
**712** 38mm face £11.05  
**714** 44mm face £12.87  
**716** 50mm face £17.01  
**720** 63mm face £22.25

- Fitted with two durable white nylon faces
- Worn faces can be instantly replaced by hand
- Serrations in the metal head prevents faces loosening in use
- Multi purpose striking tool in most assembly applications including engineering, furniture, shopfitting etc

**6. Thor Copper / Rawhide Hammers**

**208** 1" face £8.91  
**210** 1.1/4" face £12.32  
**212** 1.1/2" face £15.72  
**214** 1.3/4" face £19.85  
**216** 2" face £28.70

- Replaceable inserts
- Will not marr metalwork

**7. Emir Carpenters Mallets - Beechwood**

**213** 4" head £7.90  
**213** 4.1/2" head £10.42  
**213** 5" head £12.73  
**213** 6" head £16.13

- For general joinery work

Also available - please ask...



Warrington Hammers

Ball Pein Hammers

Brick Hammers

Brands featured here...

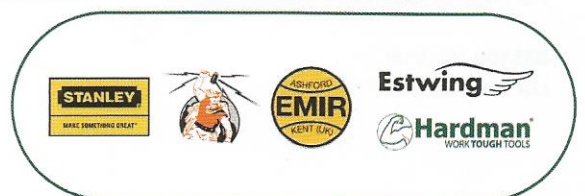

**Hardman Maxi Level**

**AT12011** 600mm  
List Price: £22.72

**AT12012** 800mm  
List Price: £20.13

**AT12013** 1000mm  
List Price: £24.67

**AT12014** 1200mm  
List Price: £36.96

**AT12015** 1800mm  
List Price: £45.86

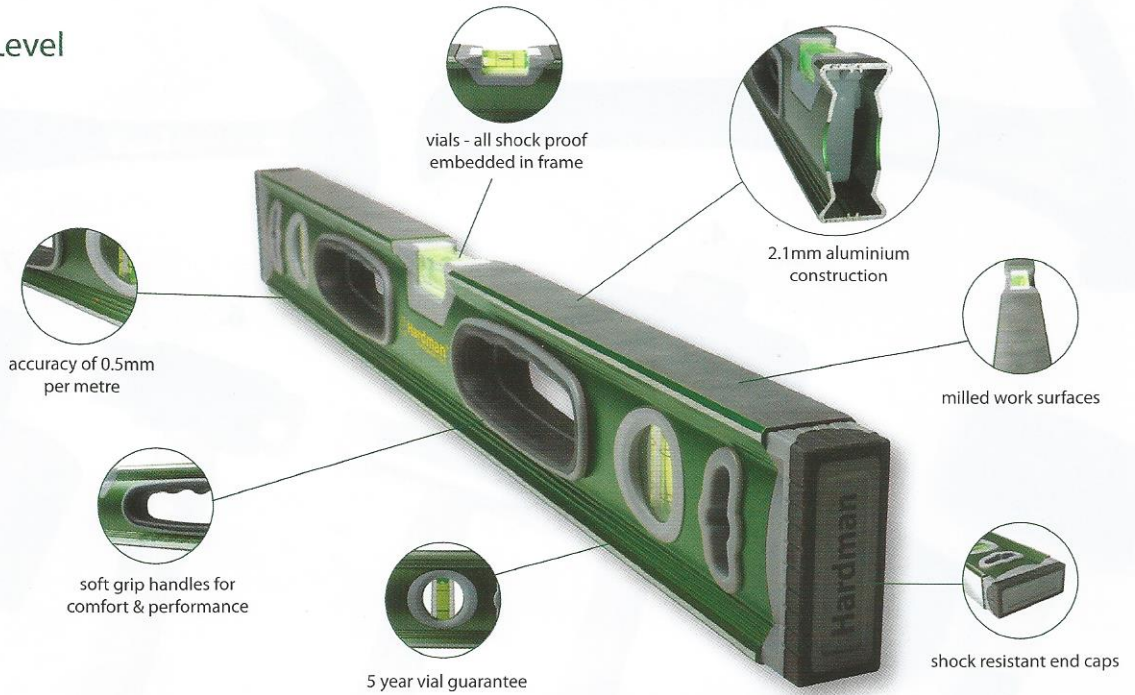

**Stanley Fatmax XL Level**

**5-43-624** 600mm  
List Price: £32.05

**5-43-648** 1200mm  
List Price: £42.72

**5-43-672** 1800mm  
List Price: £74.80

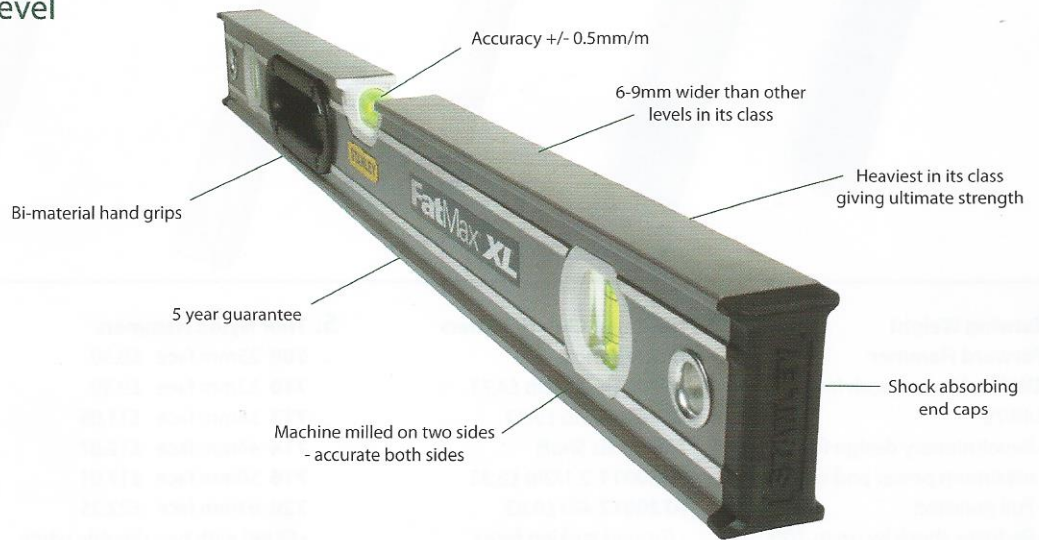

**6mm taller** than most competitors

**Stabila Girder Section Levels**

**83S40** 400mm  
List Price: £63.55

**83S60** 600mm  
List Price: £72.57

**83S80** 800mm  
List Price: £81.51

**83S100** 1000mm  
List Price: £101.75

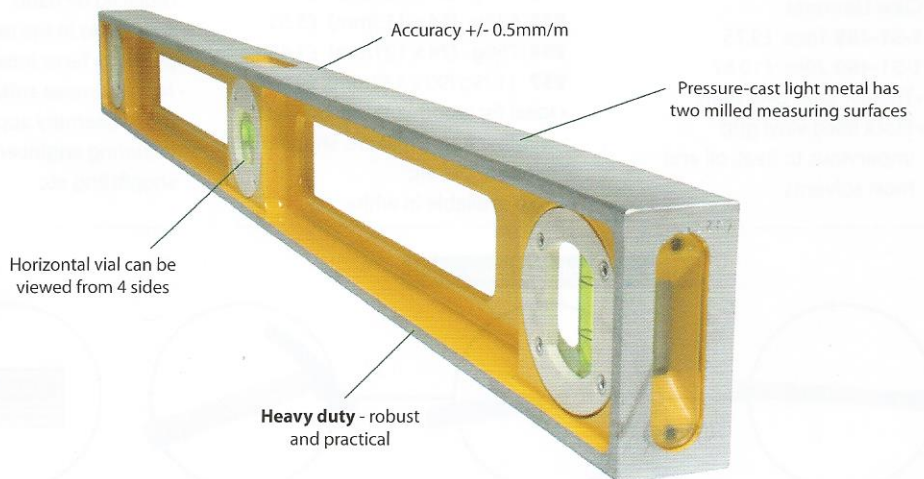



## Stanley Fatmax XL CL2 Self Levelling Cross Line Laser

1-77-153 CL2  
List Price: £139.37

**Kit includes:**

- Level
- Nylon Pouch
- Manual
- Batteries
- Mini Tripod



<p><b>Range of up to 30m</b> depending on light conditions</p>
<ul style="list-style-type: none"> <li>• Levelling accuracy of +/- 4mm @ 9mm</li> <li>• Rapidly and accurately projects both vertical and horizontal lines at the push of a button</li> <li>• 'Out-of-True' level sensor automatically alerts the user that the tool is outside its +/- 4 degrees self levelling range</li> <li>• Fitted with camera tripod mounting thread</li> </ul>



horizontal line    vertical line    cross-line    manual function



### 1. Hardman Boat Level and Line Pack

AT12000 £5.77

**230mm Boat Level**

- Durable construction
- 3 vials: horizontal, plumb and 45deg
- Rubber shock proof end caps
- Aluminium work surfaces
- Base groove allows work in plumbing and pipe work applications

**Construction Line Level**

- Aluminium construction
- For use in conjunction with stringline for brickwork and setting out

### 2. Stanley Fatmax XL Torpedo Level

5-43-609 £19.99

- Magnified centre vial for improved all round visibility
- Solid block vials provide best-in class accuracy 0.5mm/m
- V shaped metal groove for use with pipework
- Dual machined levelling surfaces for maximum accuracy
- Rare earth magnets - twice the strength of normal magnets

### 3. Stanley Torpedo Level

0-42-465 £11.82

- Strong & lightweight aluminium body ideal for small installations
- Magnetic base ideal for steel construction
- 3 vials: horizontal, plumb and 45° for wide usage
- Protected central vial for resistance to shocks

### 4. Stabila 2 Vial Boat Levels

81S10 250mm £29.31

81SM10 250mm (Magnetic) £33.81

- Made from pressure-cast light metal
- Slim bevelled shape suitable for working in tight spaces
- Milled measuring face

### 5. Stanley Line Level

0-42-287 80mm £2.69

- Lightweight metal body
- Includes hooks for using on string
- Useful for setting out levels over large areas where precision is of secondary importance e.g. landscape gardening

### 6. Stanley I Beam Pro Level

1-43-024 600mm £13.32

1-43-048 1200mm £19.99

1-43-072 1800mm £29.99

- Re-inforced I beam construction is 2 x stronger than box level
- Machine milled on both sides
- Rust free
- Shock absorbing end caps
- Accuracy +/- 1mm/m

Also available - please ask...

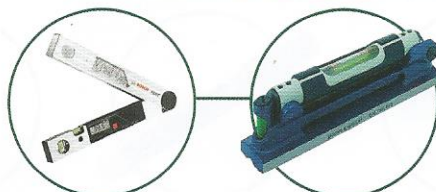

Angle Measure

Engineers Level

Brands featured here...





- 1. Hardman Chalk Line c/w chalk**  
**AT12020** Blue Refill 120g £3.18  
**AT12021** Red Refill 120g £3.18  
 • Self chalking-Leakproof reel  
 • Self locking handle

- 2. Stanley Fatmax Chalk Line Set**  
**5-47-681** £15.19  
 • ABS case - 45g chalk capacity  
 • 3.5 to 1 gear ratio for fast rewind  
 • Patented chalk view window - see exactly how much chalk you have left

- 3. Stanley Refill Chalk**  
**1-47-403** 113g Blue £2.79  
**1-47-404** 113g Red £2.79  
**1-47-405** 113g White £2.79  
**1-47-803** 225g Blue £3.70  
**1-47-804** 225g Red £3.70  
 • Blue - Exterior/interior work  
 • Red - External-indelible  
 • White - Interior-carpet fitting etc

- 4. Blackedge Carpenters Pencils**  
**34320** Blue-Soft £0.74  
**34322** Red-Medium £0.74  
**34324** Green - Hard £0.74  
 • Packs of 12 or 72

- 5. Marshalltown Braided Nylon Masons Line (Fluorescent)**  
**M631** £7.66 250" Pink  
**M632** £7.66 250" Yellow  
 • Not affected by extreme moisture  
 • For all layout applications

- 6. Cardoc Gold Seal Nylon Line**  
**1/2kg** Approx 400mtr £6.92  
 • For use with powdered chalk in large layout situations

- 7. Cardoc Masons Line**  
**No3 Orange** 18mtr £4.00 (Polyethylene)  
**Size B White** 18mtr £10.86 (Braided Nylon)  
 • Straight line reference for bricklaying etc

- 8. Cardoc Cotton Line**  
**No3** 46mtr Ball £1.50  
 • General purpose line

- 9. Stanley Black Fine Tip Permanent Markers**  
**0-47-316** Pack of 2 £1.74  
 • Marks almost any surface

- 10. Markal Ball Paint Markers**  
**BMP White** £4.82  
**BMP Yellow** £4.90  
 • Marks with real paint, dries in 5 minutes  
 • Durable metal ball tip marks on wet, oily, smooth and rough surfaces; including metal, wood, plastic, glass and any hard surface  
 • Unbreakable plastic bottle with 1/8" steel ball tip  
 • Temperature range: -50°F to 150°F (-46°C to 66°C)

Also available - please ask...

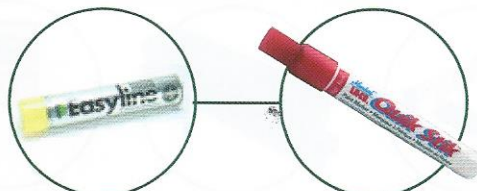

Line Marker

Quick Stick Markers

Brands featured here...





**1. Estwing Lath Hammer**

- E3/1H** £51.11
- 3.1/8" blade
  - Revolutionary cushioned shock reduction nylon vinyl grip for ultimate comfort and protection
  - Nailing and cutting battens

**2. Estwing Roofers Pick**

- E3-239mm** 21oz £49.24
- Has spike for making a hole in the slate
  - Milled Face, Vinyl Grip
  - Bradawl Claw

**3. Hardman Slaters Axe**

- AT57015** Right Handed £27.00
- For trimming and punching roofing slate
  - Hickory shaft

**4. Hardman Slaters Rippers**

- AT57017** £19.20
- Solid Forged
  - Tapered

**5. Monument Lead Dressers**

- 721P** 175mm x 50mm £17.45  
**722S** 190mm x 55mm £23.20  
**723V** 200mm x 60mm £27.08
- High density plastic for shaping Lead
  - Designed for use on sheet metal, Lead, Copper, Zinc, Aluminium etc

**6. Slate Cutter c/w Punch**

- 9995T1005** £41.62
- For cutting and punching slate tiles
  - (Plier Action Type) with spring loaded handles

**7. Leather Multitool Pouch**

- AT52015** £22.46
- Complete with hammer loops and web belt
  - Reinforced at stress points
  - Split suede leather

**8. Vitrex Heavy Duty Knee Pads**

- 302459** £10.81
- Waterproof Foam pads
  - Soft Inner padding

**9. Irwin Pro All Terrain Kneepads**

- 10503831** £18.44
- Adjustable sizing pads
  - Wide body for stable position

**10. Hardman Floor Scrapers**

- AT57030** £10.20  
200mm Light Duty  
**AT57035** £29.29  
450mm Heavy Duty  
**AT57036** £28.08  
320mm Heavy Duty
- Carbon steel blade
  - Blades angled for easy use in corners/edges
  - Steel powder coated handle

**11. Hardman Chalk Line**

- AT12020** Blue Refill 120g £3.18  
**AT12021** Red Refill 120g £3.18
- Self chalking-Leakproof reel
  - Self locking handle

Also available - please ask...



Scaffold Spanner

Brands featured here...



**1. Stanley Hobby Paint Brushes**

- 4-29-551 12mm £1.05
- 4-29-552 25mm £1.28
- 4-29-553 38mm £1.63
- 4-29-554 50mm £2.10
- 4-29-555 63mm £2.57
- 4-29-556 73mm £3.23
- 4-29-557 100mm £4.69
- 0-29-592 5pc Hobby Set £7.04

  - Budget quality black bristle paint brush ideal for general DIY decorating tasks
  - Can be used with all types of paint

**2. Stanley Decor Paint Brushes**

- 4-26-274 12mm £1.11
- 4-26-275 19mm £1.47
- 4-29-351 25mm £1.98
- 4-29-352 38mm £2.53
- 4-29-353 50mm £3.35
- 4-29-354 63mm £4.41
- 4-29-355 75mm £5.29
- 4-29-356 100mm £6.99
- 0-26-727 5pc Decor Set £10.56

  - Medium quality black bristle paint brush for use with all emulsion and acrylic paints

**3. Stanley Dynagrip Max Finish Stripping Knives**

- 0-28-650 25mm £6.37
- 0-28-651 50mm £5.79
- 0-28-652 75mm £6.61
- 0-28-653 100mm £7.29

  - Suitable for stripping paint & wallpaper
  - Fully ground stainless steel blade
  - Comfortable handle resistant to normal paint solvents

**4. Stanley Long Handled Scraper**

- 0-28-004 100mm £8.07
- 0-28-005 Spare Blades £3.77

  - Suitable for heavy duty removal of paint and adhesives
  - Angled head enables additional pressure to be applied
  - Replaceable carbide steel blades

**5. Stanley Roller Kit**

- 0-29-821 175mm £3.89
- 0-29-822 225mm £5.91

  - Contains plastic tray, 1 roller head and handle
  - Medium pile synthetic roller for applying emulsion paint

**6. Stanley Radiator Roller**

- 0-29-811 4" £5.86

  - 100mm - suitable for decorating behind radiators and awkward places
  - Supplied with two synthetic pile rollers

**7. Stanley Mini Roller Kit**

- 0-29-480 100mm £3.99

  - Contains plastic tray, 2 roller heads and handle
  - Fabric roller head for applying emulsion paint
  - Foam roller head for applying gloss paint

**8. Stanley Roller Refills**

- 4-29-489 9" Medium Pile £2.49
- 4-29-487 9" x 1.3/4 Long Pile £2.99
- 4-29-863 7" Medium Synthetic £1.99
- 4-29-864 9" Medium Synthetic £2.41

  - Replacement sleeves for the Stanley range of decorating rollers

**9. Stanley Razor Edge Scraper**

- 0-28-500 £3.80

  - Retractable blade razor blade scraper with five single edge blades

**10. Builders Tarpaulin**

- 2896T129694 £15.15

  - Heavy Duty re-usable waterproof sheets
  - Ideal temporary cover with many uses in the home and garden

**11. Dust Sheet - Cotton Twill**

- 2896T129689 £12.99

  - Durable heavy-duty dust sheets - 100% Cotton Twill
  - Washable and reusable

Brands featured here...





**Box Quantities** - e.g (6) = Box of 6  
**List prices** - per item in box

**1. White Spirit**

**WHSB2000** 2L (6) £3.13 each  
**WHSB0750** 750ml (12) £1.60 each  
 • Petroleum solvent, ideal as a thinner for paints due to its high solvency powers, quick drying properties and lack of greasiness

**2. Creocote**

**(Creosote Substitute)**  
**CRCOD04D** 4L Dark (4) £8.05 each  
**CRCOD04L** 4L Light (4) £8.05 each  
 • Traditional Creocote

**3. Methylated Spirits**

**M MSP0500** 500ml (12) £1.43 each  
 • For thinning French Polish, cleaning brushes after knotting, cleaning glassware etc.  
 • Can be used as a fuel in certain lamps, check instructions before use

**4. Turps Substitute**

**TUSU2000** 2L (6) £4.05 each  
 • A cheaper solvent used as a general purpose cleaning solvent and also as a pain thinner where quick drying is of less importance

**5. Drain & Toilet Cleaner**

**KOAK1000** 1L (4) £4.40 each  
**KOKB0500** 500ml (12) £2.48 each  
 • Sulphuric acid based product (with inhibitor) specially designed to rapidly clear blockages in drains pipes and toilets  
 • Industrial strength for trade and professional use

**6. Pathway & Patio Cleaner**

**PCAK4000** 4L (4) £4.95 each  
 • Acid based cleaner, removes grime, dirt, leaf stains and is suitable for cleaning brick work

**7. Caustic Soda**

**CASO0500** 500g (12) £1.83 each  
 • Strips paint, cleans wood and clears blocked drains

**8. Kitchen & Bathroom Cleaner**

**KOKB0500** 500ml (6) £4.45 each  
 • A sodium hydroxide solution specially designed to clear fat, grease and hair in kitchen sinks, baths & showers

**9. Paint Remover / Stripper**

**STPS1000** 1L (6) £5.38 each  
 • A traditional product that will remove most paints, varnishes etc

Brands featured here...





- 1. Electrical Insulation Tape**  
**19mm x 20mtr** £5.38 / 10  
 Black/Blue/Green/Red/White  
**19mm x 20mtr** £7.50 / 10  
 Green/Yellow  
 • Flame retardant  
 • Manufactured to BS3924

- 2. Barrier Tape**  
**70mm x 500mtr** £5.51  
 Black/Yellow  
 • Non adhesive, strong and durable PVC tape

- 3. Hazard Warning Tape**  
**50mm x 33mtr** £2.96  
 Black/Yellow  
 • Adhesive backed  
 • For marking hazardous areas

- 4. Brown Parcel / Opp Tape**  
**48MMX66MT** £0.99  
 Brown  
 • Self adhesive for parcels and packages

- 5. Cloth Tape**  
**50mm x 50mtr** £3.51  
 Black/Silver  
 • Heavy duty and waterproof

- 6. Masking Tape**  
**19mm x 50mtr** £0.49  
**25mm x 50mtr** £0.64  
**38mmx 50mtr** £0.98  
**50mm x 50mtr** £1.27  
**75mm x 50mtr** £1.98

- 7. PTFE Tape**  
**5401/2" x 40ft** £0.58  
 • For sealing screw threads in pipe work

- 8. Araldite DIY Adhesive**  
**80809** 2 Tube Pack £4.28  
**95590** 2x100ml (2011) Standard Pack £27.29  
 • Slow setting strong adhesive  
 • Water resistant

- 9. Araldite Rapid Adhesive**  
**80811** 2 Tube Pack £5.96  
**95591** 2 x 100ml (2012) £33.29  
 • Fast setting, water resistant

- 10. Arrow Glue Sticks**  
**AP10** 10"x1/2" Pack of 12 £7.50  
**AP2000** 10"x1/2" Bulk £155.60  
**AP5** 4"x1/2" Pack of 6 £1.70  
**BAP5** 4"x1/2" Pack of 24 £6.20  
 • Set in 30 to 60 seconds

- 11. Arrow TR550 Glue Gun Kit**  
**TR550** Glue gun kit  
 c/w 12 glue stix £22.20  
**95591** 2X100ML(2012) £33.29  
 • Mains operated powerful model  
 • Easy squeeze lever for precise glue control

- 12. Dunlop Thixofix Adhesive**  
**500ml** £9.47  
**1 Litre** £18.29  
**2.5 Litre** £40.11  
**5 Litre** £70.99  
 • Simple way of bonding laminated plastics to wood and other substrates

- 13. Laco Epoxy Putty Stick**  
**EP159** Stick £7.63  
 • Plugs or seals almost anything  
 • Sets steel hard in 20 minutes

- 14. Gorilla Glue**  
**8300TGG02** 2oz (Qty 16) £4.95  
**8300TGG04** 4oz (Qty 16) £7.95  
**8300TGG08** 8oz (Qty 9) £12.95  
 • 100% waterproof  
 • Incredibly strong and versatile  
 • Stainable, paintable and easily sanded  
 • Open working time of 20 mins  
 • Acid-free & non-toxic when cured  
 • Expands 3 to 4 times its size so only small amount required

- 15. Loctite Super Glue**  
**0001612** 5gm £4.77  
 • High performance formula bonds in seconds  
 • Suitable for a variety of surfaces, including metal, wood, leather and most plastics

Brands featured here...





**1. Wiss Compound Action Snips**

- M1R** Left Hand Cutting £24.45
- M2R** Right Hand Cutting £24.45
- M3R** Straight Cutting £24.45

- Non-slip serrated jaws, made of extra tough, wear-resistant molybdenum steel
- Withstands severe strain of cutting heavy stock and tight curves

**2. Wiss Compound Action Snips**

- MPX** 10 1/2" £24.45
- All purpose cutter with 3 serrated blades providing longer cut length
- Exceptional cutting capabilities with less effort
- Makes quick work of cutting cardboard, wire mesh, sheet metal, sheet vinyl and many other materials

**3. Gilbow General Purpose Tinsnips**

- G2458** 8" £15.33
- G24510** 10" £18.58
- G24512** 12" £20.78
- G24514** 14" £26.27
- Cutting capability much greater than the strength of the user
- Accurate ground edges ensure the material being cut cannot slip out of the jaws
- Hollow ground jaw faces preserve the life of the cutting edge

**4. Irwin Record Cable Cutters**

- WC16** £125.37
- CC26** £104.57
- Medium duty general purpose
- For copper and aluminium

**5. Irwin Record Bolts Cutters Arm Adjustment Centre Punch**

- 914H** £103.46
- 918H** £127.31
- 924H** £157.30
- 936H** £261.48
- 942H** £351.87
- Heavy duty, arm adjusted
- Consists of two drop-forged steel handles

**6. Stanley Max Steel Aviation Snips**

- 2-14-562** Left Cut £13.49
- 2-14-564** Right Cut £13.49
- 2-14-563** Straight Cut £13.49
- Serrated cutting edges to prevent slippage when cutting
- Bi metal handle for comfort grip
- Cuts up to 18 gauge steel

**7. Irwin Gilbow Heavy Duty Cranked Handle Shears**

- G67** 11" Left Handed £34.80
- G69** 11" Right Handed £35.43
- G691** 14" Right Handed £45.68
- Cutting capability much greater than the strength of the user

**8. Hardman Bolt Croppers**

- AT55001** 18" 7mm Capacity £11.78
- AT55002** 24" 9mm Capacity £16.55
- AT55003** 30" 11mm Capacity £22.49
- AT55004** 36" 13mm Capacity £28.71
- Suitable for cutting mild steel bars & bolts, chains and metal sections

**9. Irwin Gilbow Jewellers Snips**

- G56** 7" Straight £18.10
- G056** 7" Curved £26.22
- For light duty usage - jewellery and precious metals

**10. Wiss General Purpose Wezsnips**

- 4793TWEZSNIP** £6.71
- For light duty cutting

Also available - please ask...



Offset Snips

Brands featured here...



### Irwin Quick-Grip Bar Clamp

Code	Size	List Price
506QC	6"/150mm	£16.82
512QC	12"/300mm	£18.81
518QC	18"/450mm	£20.79
524QC	24"/600mm	£23.76
536QC	36"/900mm	£29.70
536QC	50"/1250mm	£36.63

Non-marking pads for a firmer grip without damaging delicate surfaces

Jaw can be positioned anywhere on bar

Quick-release trigger

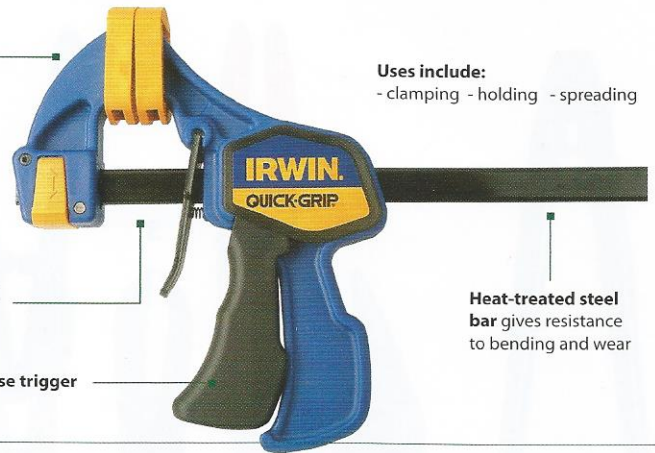

Uses include:

- clamping - holding - spreading

Heat-treated steel bar gives resistance to bending and wear

### Irwin Record Sash Clamps 135

- Slides and heads are flat bottomed so the clamp will stand without support
- Slide and head guaranteed unbreakable

Code	Size	List Price
1352	24" / 30" overall	£36.66
1353	30" / 36" overall	£38.10
1354	36" / 42" overall	£40.16
1355	42" / 48" overall	£42.75
1356	48" / 54" overall	£43.63
1357	54" / 60" overall	£44.64
1359	66" / 72" overall	£45.66
L1354	36" Lengthening Bar	£29.46



### Irwin Record 120 'G' Clamps

- For both metal and woodworking applications
- Strong ribbed cast steel frame

Code	Size	List Price
1203	3"	£15.46
1204	4"	£15.88
1206	6"	£22.74
1208	8"	£35.41
12010	10"	£54.75
12012	12"	£76.87



### Irwin Record 'T' Bar Clamps

- Fixed head has drilled feet for bench mounting
- Slide and head guaranteed unbreakable

Code	Size	List Price
1365	42" / 48" overall	£51.99
1366	48" / 52" overall	£54.08
1367	54" / 60" overall	£54.84
1369	66" / 72" overall	£59.84
13611	78" / 84" overall	£70.90
L1366	48" Lengthening Bar	£43.36



### Hardman 'G' Clamps

- Castellated thread for robust clamping
- Girder construction

Code	Size	List Price
AT25001	3"	£3.11
AT25002	4"	£4.44
AT25003	6"	£6.80
AT25004	8"	£9.24
AT25005	10"	£10.40
AT25006	12"	£12.59



### Hardman Heavy Duty Sash Clamps

Code	Size	List Price
AT25013	24"	£15.00
AT25014	36"	£15.90
AT25015	48"	£18.46
AT25016	60"	£22.33
AT25017	72"	£24.33

- Heavy duty T-bar construction
- Robust thread formation for gripping strength
- Ground & polished faces
- To calculate 'working length' please deduct 6" from size stated

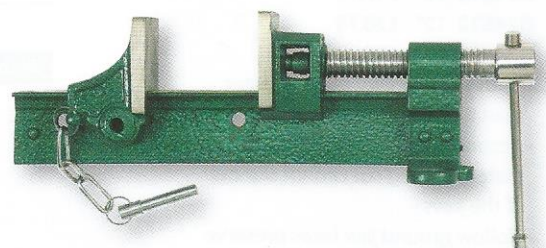



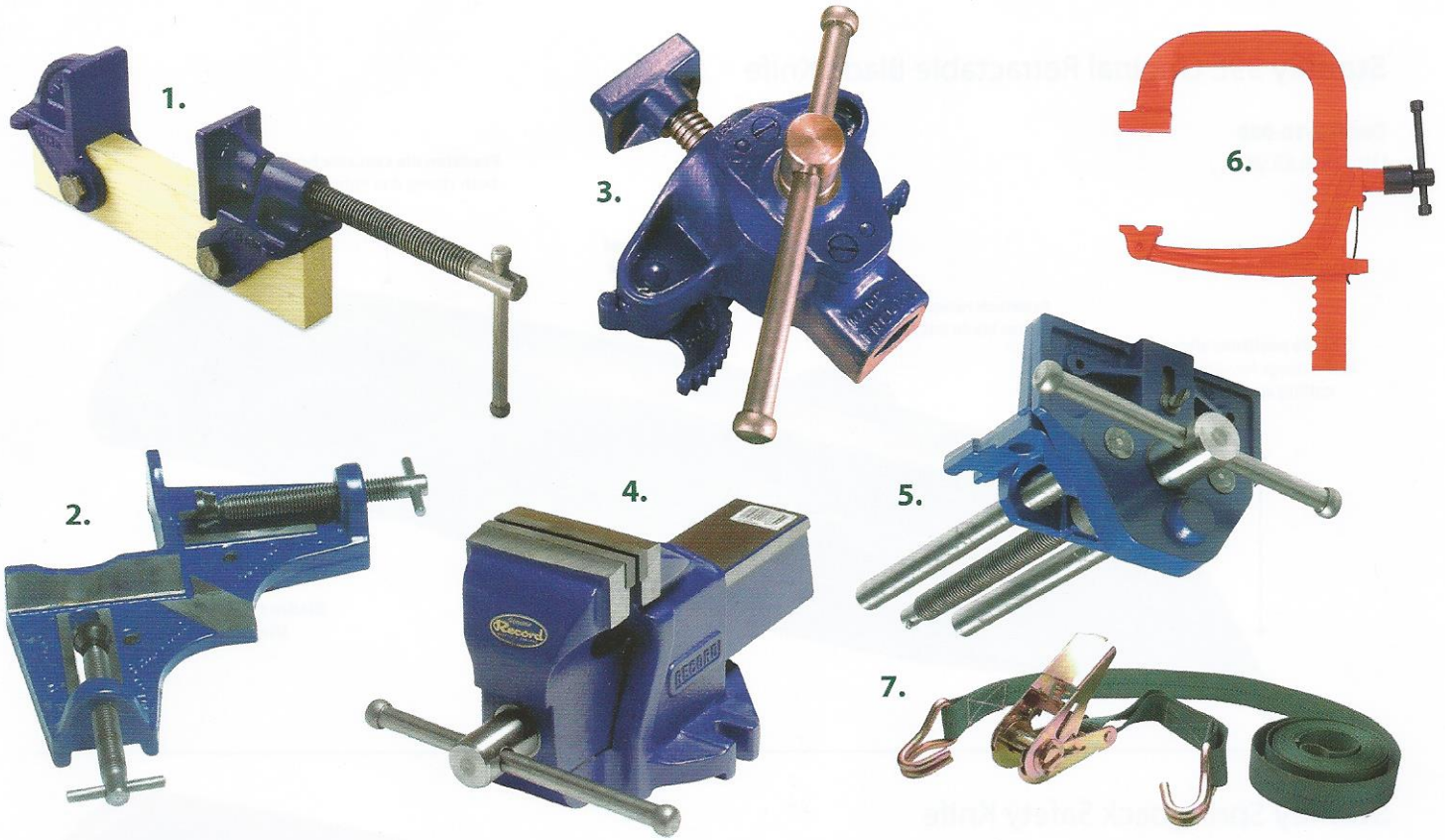

### 1. Irwin Record Clamp Heads

**M130** £18.77

- Low cost alternative to full size bar clamps
- The gray cast iron head and slide with steel mainscrew can be fitted to a wooden batten 1"/25mm thick by 1.1/2"/38mm wide and any length

### 2. Irwin Record Corner Clamp

**M140** 2" £14.21

**M141** 4.1/2" £50.33

- Provides accurate mitre clamping
- Solid gray iron bodies are precision machined clamping to give a positive location and easy access for glueing and nailing

### 3. Irwin Record Flooring Clamp

**MFC153** 3"/75mm £183.26

- Designed to close up floorboards prior to nailing
- For standard 3"/75mm joists

### 4. Irwin Record Mechanic's Vice

**No.1** 3" Jaw width £47.64

**No.3** 4" Jaw width £92.66

**No.4** 4.1/2" Jaw width £162.58

**No.5** 5" Jaw width £188.31

**No.6** 6" Jaw width £280.15

**No.8** 8" Jaw width £500.07

- Most commonly used of all metal work vices
- The sliding section of the vice will not fall out when fully extended
- Handle is specially designed to bend before vice is over stressed

### 5. Irwin Record Woodworking Vice

**52PD** 7" Plain Screw £60.75

**52 12PD** 9" £80.50

**53PD** 10.1/2" £89.41

**52ED** 7" Quick Release £127.59

**52.1/2ED** 9" £177.21

**53ED** 10.1/2" £189.03

- Manufactured in three capacities, this full size workshop vice is designed for bench mounting
- Also available in quick release

### 6. Carver Standard Duty Rack Clamps

**T186150** 150mm / 6" £62.00

**T186300** 300mm / 12" £72.42

**T186750** 600mm / 24" £90.08

**T321600** 24" Long Reach £113.01

- For welding, metal fabrication, moulding box & die holding etc
- Spring loaded jaws stays in position when pressure removed
- Finished in a bright orange epoxy coating for durability
- \* 24" Long Reach pictured

### 7. Hardman Ratchet Tie Downs

**AT59001** 4m x 25mm 2 Claw

0.75 Tonne £4.23

**AT59002** 4m x 35mm 2 Claw

3 Tonne £12.91

**AT59003** 8m x 48mm 2 Claw

5 Tonne £20.13

- Quick release mechanism
- Suitable for transport and building industries and home
- Tested to 750kg, 3 Tonne & 5 Tonne respectively

Also available - please ask...



Record Drill Press Vices

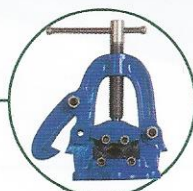

Record Pipe Vice



Record Chain Pipe Vice

Brands featured here...

**IRWIN**  
Industrial Tools

**Hardman**  
WORK TOUGH TOOLS

**IRWIN**  
Record.

**CARVER**  
CARVER & CO (ENGINEERS) LTD

### Stanley 99E Original Retractable Blade Knife

Code: 2-10-099

List Price: £5.99

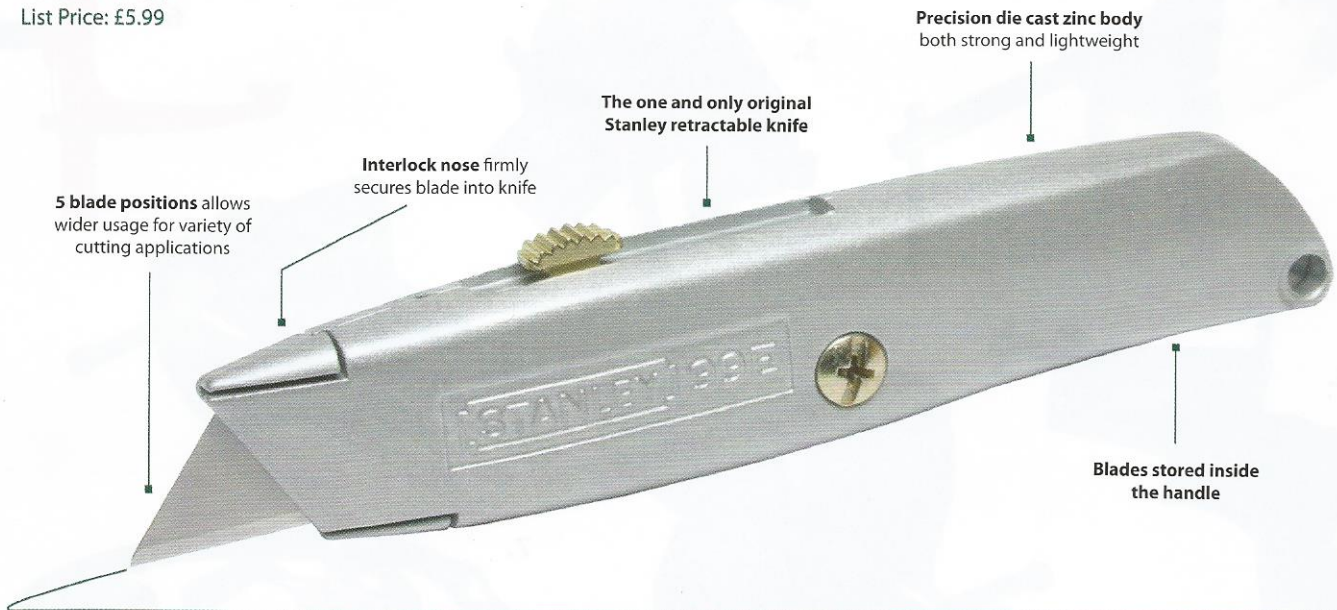

### Stanley Springback Safety Knife

Code: 1-10-189

List Price: £7.00

- The blade remains outside as long as a thumb is kept on the push button and retracts automatically when the button is released



### Stanley Classic 199 Fixed Blade Knife

Code: 2-10-199

List Price: £4.09

- Zinc alloy body with overlapping nosepiece for safety



### Hardman Springback Utility Knife

Code: AT17003

List Price: £3.20

- Blade automatically springs back when thumb push is released





**1. Stanley Quick Slide Pocket Knife**

- 5-10-810** £7.42
- One handed operation
  - blade extender
  - Metal body

**2. Stanley Titan Knives**

- 1-10-550** Fixed Blade with Scabbard £12.50  
**1-10-122** Retractable Blade with Scabbard £14.50
- Lightweight aluminium body
  - Locking brass wheel

**3. Stanley Instant Change Retractable Knife**

- 1-98-456** £9.90
- Easier to operate and change blades
  - Improved comfort grip

**4. Hardman Self Loading Utility Knife**

- AT17005** £4.53
- Automatic blade change
  - Simple to load

**5. Stanley FatMax XL Knife**

- 5-10-819** Retractable Knife £13.93  
**5-10-818** Fixed Blade £13.01
- Larger body than standard knives
  - Allows for gloved use



**6. Hardman Quick Change Knife**

- AT17004** £4.00
- Integrated wire stripper
  - Simple blade change

**7. Stanley SM Snap Off Blade Knives**

- 0-10-150** 9mm Blade £1.54  
**0-10-151** 18mm Blade £2.06
- Segmented blade allows for continual sharp edge

**8. Stanley Disposable Craft Knife**

- 0-10-601** Card of 3 £2.06  
**1-10-601** Box of 50 £34.50  
**5-10-601** Box of 400 £159.81
- Plastic body - Precision blade

**9. Stanley 110mm Folding Pocket Knife**

- 0-10-598** £7.21
- Pocket knife with folding precision blade.

**10. Stanley Window Scraper**

- 0-28-590** £1.46
- Ideal for removing excess paint from windows

**11. Stanley 1992 Heavy Duty Blades**

- 0-11-921** Card of 5 £1.54  
**3-11-921** Dispenser of 10 £2.28  
**1-11-921** Box of 100 £22.64  
**4-11-921** Box of 400 £82.39
- Fits all standard knives
  - General purpose blade

**12. Economy Heavy Duty Blade**

- 7751TBLADE** Box of 100 £9.24
- Heavy duty knife blade
  - Made in Sheffield
  - Fits most knives

**13. Hardman Replacement Knife Blades**

- AT17009** Dispenser of 100 £5.74  
**AT17010** Cassette Pack of 10 £0.60
- Suitable for most standard knives

**14. Stanley 1996 Hooked Blades**

- 0-11-983** Card of 5 £1.54  
**3-11-983** Cassette of 10 £2.57  
**1-11-983** Box of 100 £25.76
- Ideal for cutting sheet material, flooring and plastic sheeting.

**15. Stanley 59 Slimknife Blades**

- 0-11-221** Card of 3 £1.84  
**1-11-221** Box of 50 £20.60  
**1-11-115** Box of 50 Curved £22.64
- For precision moulding and craftwork

Brands featured here...



**1. Stanley Combination Square****0-46-151** £30.00

- Cast iron stock-machined faces for accuracy
- Incorporates 45° and 90° faces
- English/metric graduated rule

**2. Hardman Combination Square****AT13100** £5.68

- Die cast zinc alloy stock
- English/metric graduated rule

**3. Hardman Layout Folding Square****AT13006** 600mm £16.04**AT13007** 1200mm £22.64

- Ideal for laying floors / patios / paving / partitions

**4. Stanley Roofing Square****2-45-600** £29.99 Metric/Imperial**1-45-530** £26.00 Metric

- 600mm x 400mm
- Steel square with reversed reading scale

**5. Fisher Roofing Square***Light Duty***F1140IMR** £14.68*Heavy Duty***F1240IMR** £20.10

- 16" x 24" Aluminium Finish
- Economical alternative for light usage
- Metric/imperial scale markings on either face

**6. Marples Carpenters Square****M2200** 6" £26.14**M2200** 9" £30.62**M2200** 12" £37.37

- Hardened steel blade which is secured by three steel rivets with brass washers, preventing movement
- Sealed rosewood stock faced with brass for extra protection against damage and to give longer life and better accuracy

**7. Stanley Sliding Bevels****0-46-525** 190mm £10.64**0-46-529** 228mm £11.40**0-46-535** 267mm £11.96

- Ideal for transposing angles
- Plastic moulded stock
- Hardened steel blade

**8. Marples Marking Gauges****M2153** £31.90

Mortice &amp; Marking

**M2049** £10.24

Marking Only

- Hardwood body - integral brass fittings

**9. Stanley Adjustable Quick Square****0-46-050** 6" £16.00**0-46-052** 16" £19.99

- Can be used as a bevel, protractor or saw guide
- Ideal for marking repetitive cuts
- 3 main roofing scales marked
- Alloy construction
- Permanent markings

**10. Marshalltown Dry Wall T Square****M27** 48" x 22" £24.15

- Silver anodised finish
- Used for plasterboard measurement and cutting guide

Brands featured here...



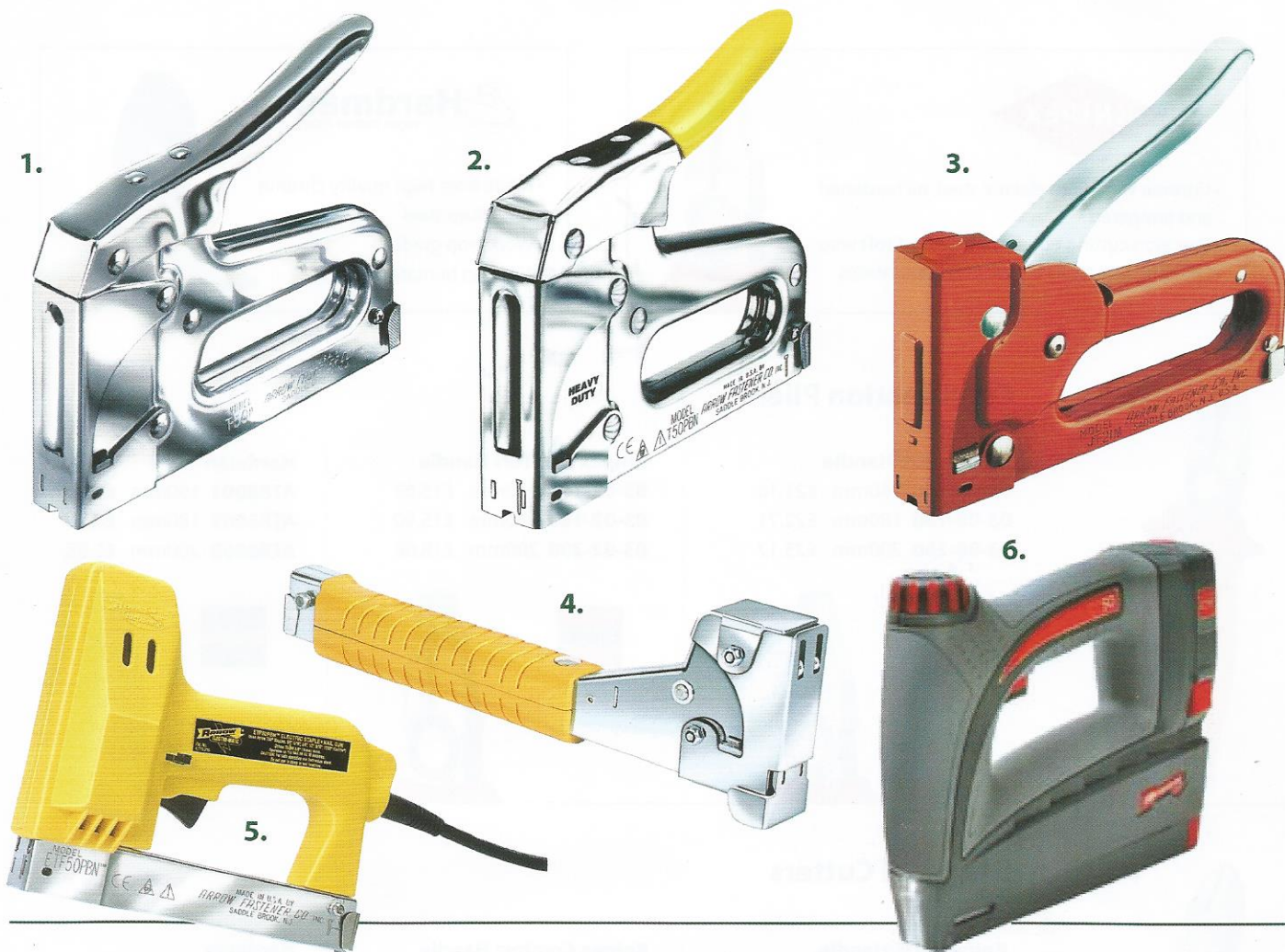

## Staple Guns & Hammer Tackers

### 1. Arrow Heavy Duty Staple Gun

- T50** £30.22
- All steel construction
  - Shoots T50 staples - 6 sizes
  - Jam proof mechanism
  - Ideal for roofing, flooring and upholstery

### 2. Arrow Professional Heavy Duty Staple & Nail Gun

- T50PBN** £32.68
- Shoots staples up to 14mm
  - Drives brad nails 15mm
  - Uses T50 staples and BN18101P brad nails
  - Ideal for picture framing, roofing, flooring and upholstery

### 3. Arrow Junior Staple Gun

- JT21** £15.10
- All steel construction
  - For light duty work
  - Shoots JT21 staples
  - Jam proof mechanism

### 4. Arrow Heavy Duty Hammer Tacker

- HT50A** £45.10
- All steel construction
  - Use 3 types of T50 staples: 8mm, 10mm, 12mm
  - Ideal for carpeting, insulating, upholstery
  - Durable chrome finish
  - Patented jam-proof mechanism

### 5. Arrow Electric Staple & Nail Gun

- ETFX50** 230V £54.44
- Powerful 14amps of surge power
  - Ergonomic comfort and styling
  - Shoots T50 Staples - 6 sizes
  - Drives Brad Nails 15mm BTN18101P

### 6. Arrow Cordless Li-Ion Stapler

- CT50K** £79.99
- Lithium-Ion battery power 10.8V
  - Drives 1500 staples on 1 charge
  - c/w battery charger
  - Adjustable drive depth
  - Shoots T50 staples up to 14mm

## Staples

Staples are priced by boxes of 5000

### 7. Arrow Staples JT21

- (per 5000)
- JT21014** 6mm £7.45
- JT21516** 8mm £7.45
- JT21038** 10mm £8.45



### 8. Arrow Staples T50

- (per 5000)
- 4935T014** 6mm £7.45
- 4935T015** 8mm £7.55
- 4935T016** 10mm £8.45
- 4935T018** 12mm £9.25
- 4935T019** 14mm £10.20



Brands featured here...

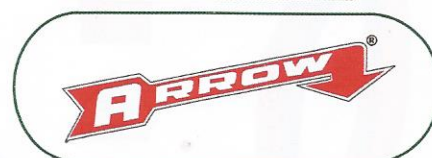



- Chrome vanadium electric steel, oil hardened and tempered
- Precision cutting edges for hard and soft wire
- Differing jaw styles for varying applications



- Made from high quality chrome vanadium steel
- Workshop grade
- Non slip bi-material handles



## Combination Pliers

### Knipex VDE Handle

**03-06-160** 160mm £21.16  
**03-06-180** 180mm £22.71  
**03-06-200** 200mm £25.17



### Knipex Comfort Handle

**03-02-160** 160mm £15.62  
**03-02-180** 180mm £15.90  
**03-02-200** 200mm £18.08



### Hardman

**AT86001** 160mm £4.20  
**AT86002** 180mm £4.70  
**AT86003** 200mm £5.55



## Diagonal Cutters

### Knipex VDE Handle

**70-06-125** 125mm £22.77  
**70-06-140** 140mm £24.08  
**70-06-160** 160mm £25.80  
**70-06-180** 180mm £27.63

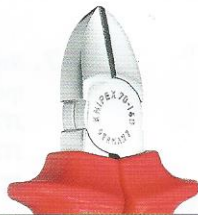

### Knipex Comfort Handle

**70-02-125** 125mm £18.59  
**70-02-140** 140mm £18.88  
**70-02-160** 160mm £19.37  
**70-02-180** 180mm £20.71



### Hardman

**AT86010** 140mm £3.35  
**AT86011** 160mm £4.90



## Long Nose Pliers

### Knipex VDE Handle

**25-06-160** 160mm £22.34  
**26-16-200** 200mm £28.49



### Knipex Comfort Handle

**25-02-160** 160mm £18.08  
**26-12-200** 200mm £22.25



### Hardman

**AT86020** 160mm £3.20  
**AT86021** 200mm £5.95





### 1. Knipex Circlip Pliers

#### External Straight

- 44-11-A1 140mm £13.56
- 46-11-A2 180mm £14.81
- 46-11-A3 210mm £16.02
- 46-11-A4 320mm £27.05

#### External Bent

- 46-21-A11 125mm £14.70
- 46-21-A21 170mm £16.02
- 46-21-A31 200mm £17.62

- Fitting external circlips on shafts from 3mm - 400mm diameter

- Solid style, forged
- Non-slip, solid tips

#### Knipex Circlip Pliers (cont)

#### Internal Straight

- 44-11-J1 140mm £12.47
- 44-11-J2 180mm £13.21
- 44-11-J2 225mm £14.81

#### Internal Bent

- 44-21-J11 130mm £14.01
- 44-21-J21 170mm £14.30
- 44-21-J31 215mm £15.62

- Fitting internal circlips in bore holes from 8mm - 400mm diameter
- Solid style, forged
- Non-slip, solid tips

### 2. Knipex Cobra Pliers

- 87-01-180 180mm £23.80
- 87-01-250 250mm £25.11
- 87-01-300 300mm £34.09
- 87-01-400 400mm £58.34
- 87-01-560 560mm £93.98

- Ideal for service & maintenance, equipment repair, automotive and general industry
- One hand fine adjustment by pushing a button
- Self locking on pipes and nuts, no slipping on workpiece

### 3. Knipex Alligator Pliers

#### VDE Handle

- 88-06-250 250mm £31.57

#### Comfort Handle

- 88-02-250 250mm £18.93

#### Standard Handle

- 88-01-300 300mm £27.36

- Box-joint design: high stability because of double guide
- Self locking on pipes and nuts, no slipping on workpiece

### 4. Knipex High Leverage Diagonal Cutters

#### Comfort Handle

- 74-02-160 160mm £22.34
- 74-02-180 180mm £25.68
- 74-02-200 200mm £27.28
- 74-02-250 250mm £32.18

- Forged-on axle for heaviest duty work
- Suitable for all types of wire including piano wire
- 250mm is suitable for copper conductors up to 16mm<sup>2</sup> and aluminium conductors up to 35mm<sup>2</sup>

### 5. Knipex End Cutting Nippers

- 68-01-160 160mm £12.87
- 68-01-180 180mm £15.04
- 68-01-200 200mm £18.65

- With cutting edges for soft and hard wire
- Also suitable for twisting and cutting binding wire

### 6. Knipex Wire Rope Cutter

- 95-61-190 190mm £35.58

- For medium hard wire up to 6mm diameter
- With opening spring and locking lever

### 7. Groove Joint Pliers

- AT86030 250mm £8.56

- Made from high quality chrome vanadium steel
- Workshop grade

### 8. Hardman Wire Stripper

- AT86040 160mm £5.29

- Spring for re-opening polished head
- Adjustable screw to set required diameter

### 9. Knipex VDE Wire Stripper

- 11-06-160 6" £26.20

- Easy adjustment for diameter with knurled screw and lock nut

Also available - please ask...



Revolving Punch Plier

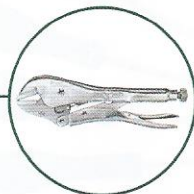

Vise Grip Locking Plier

Brands featured here...



## Stanley Fat Max Screwdriver



**Chrome vanadium steel bar**  
allows for high torque and  
reduces the chance of tip breakage

**Handle moulded direct to bar** virtually  
unbreakable bond. Highly reliable and  
providing an extra long life

**Soft grip handle** - perfect  
combination of great grip  
plus reduces fatigue

**Large diameter handle** offers  
great torque needed for driving  
wood screws

**Colour coded ends**  
for easy identification of the 'right'  
screwdriver for each screw type



## Stanley Fatmax 12 Piece Screwdriver Set

5-65-426 £34.87

Set Contains:

### Parallel

- 2.5mm x 50mm
- 4.0mm x 100mm
- 5.5mm x 150mm
- 6.5mm x 30mm  
(stubby)

### Phillips

- PH0 x 75mm
- PH1 x 100mm
- PH2 x 125mm

### Pozi

- PZ0 x 75mm

### Flared

- 5.5mm x 100mm
- 8.0mm x 150mm



## Stanley Fatmax 9 Piece Screwdriver Set

5-65-424 £30.86

Set Contains:

### Parallel

- 3.0mm x 50mm
- 4.0mm x 100mm
- 6.5mm x 30mm

### Flared

- 5.5mm x 100mm
- 6.5mm x 150mm
- 8.0mm x 150mm

### Pozi

- PZ0 x 75mm
- PZ1 x 100mm
- PZ2 x 125mm



## Pozi Drive



Code	Description	List Price
0-65-319	PZ0 x 75mm	£3.37
0-65-335	PZ1 x 100mm	£3.85
0-65-336	PZ1 x 250mm	£4.82
0-65-337	PZ2 x 125mm	£4.82
0-62-571	PZ2 x 250mm	£5.78
0-62-338	PZ3 x 150mm	£5.78
0-65-339	PZ4 x 200mm	£7.70
0-65-408	PZ1 x 30mm	£2.88
0-65-409	PZ2 x 30mm	£3.85

## Parallel



Code	Description	List Price
0-65-006	2.5 x 50mm	£2.40
0-64-978	3 x 50mm	£2.68
0-65-008	3 x 100mm	£3.07
0-65-979	3 x 150mm	£3.37
0-64-983	3.5 x 75mm	£2.88
0-64-984	3.5 x 100mm	£3.17
0-65-484	4mm Stubby	£2.88
0-65-017	4 x 100mm	£3.37
0-65-093	4 x 150mm	£3.37
0-65-400	5.5mm Stubby	£3.37
0-65-476	5.5 x 125mm	£4.05
0-65-094	5.5 x 150mm	£4.14
0-65-404	6.5mm Stubby	£3.85
0-65-096	6.5 x 150mm	£5.29
0-65-097	6.5 x 200mm	£5.78

## Flared



Code	Description	List Price
0-65-477	2.5 x 50mm	£2.40
0-65-478	2.5 x 75mm	£2.68
0-65-479	3 x 75mm	£2.68
0-65-480	3 x 100mm	£2.88
0-65-481	4 x 125mm	£3.55
0-65-482	5.5 x 125mm	£4.14
0-65-483	5.5 x 150mm	£4.32
0-65-141	6.5 x 150mm	£5.29
0-65-137	8 x 150mm	£5.78
0-65-138	8 x 175mm	£6.26
0-65-139	10 x 200mm	£6.74
0-65-143	12 x 250mm	£7.70

## Phillips



Code	Description	List Price
0-65-204	PH00 x 50mm	£3.17
0-65-206	PH0 x 75mm	£3.37
0-65-207	PH1 x 100mm	£3.85
0-65-208	PH1 x 250mm	£4.82
0-65-209	PH2 x 125mm	£5.29
0-65-224	PH2 x 250mm	£5.78
0-65-316	PH3 x 150mm	£5.78
0-65-317	PH4 x 200mm	£7.70
0-65-406	PH1 x 30mm	£2.88
0-65-407	PH2 x 30mm	£3.85



## Hardman Screwdriver Range

Backed by the Hardman unequivocal guarantee



Hardened chrome vanadium blades - workshop grade

Larger sizes with bolster for spanner leverage

Proven grip in oily conditions

Ergonomically designed bi-material soft grip handles for greater torque

Handles can be colour co-ordinated for 'own branding'



### Hardman 6 pcs Screwdriver Set

AT01050 £13.25

- Set contains:
- 5.5 x 100mm Flared
- 6 x 150mm Flared
- 8 x 150mm Flared
- 3 x 100mm Parallel\*
- PZ1 x 75mm
- PZ2 x 100mm

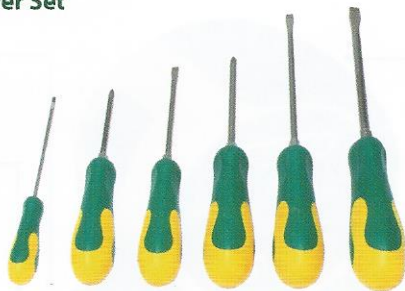

- Complete with hex bolster (\* no bolster)
- Chrome vanadium hardened blades
- Ergonomic soft grip handle for comfortable use

### Hardman 6 pcs VDE Screwdriver Set

AT01060 £17.26

- Set contains:
- 3 x 75mm Slotted
- 5.5 x 125mm Slotted
- 6.5 x 150mm Slotted
- PH1 x 80mm
- PH2 x 100mm
- GS Tester



- Certified to DIN EN 60900
- For use up to 1000V a.c and 1500V d.c



### Slotted



Code	Description	List Price
AT01000	5.5 X 100mm c/w hex bolster	£2.40
AT01001	6 X 150mm c/w hex bolster	£2.75
AT01002	8 X 150mm c/w hex bolster	£3.10
AT01003	8 X 200mm c/w hex bolster	£3.45
AT01004	10 X 250mm c/w hex bolster	£6.24
AT01010	3 X 100mm	£1.60
AT01011	3 X 150mm	£1.75



### Pozi



Code	Description	List Price
AT01020	PZ0 X 60mm	£2.05
AT01021	PZ1 X 75mm c/w hex bolster	£2.40
AT01022	PZ2 X 100mm c/w hex bolster	£2.75
AT01023	PZ3 X 150mm c/w hex bolster	£4.35
AT01024	PZ1 X 250mm c/w hex bolster	£3.65
AT01025	PZ2 X 250mm c/w hex bolster	£4.15



### Phillips



Code	Description	List Price
AT01030	PH1 X 75mm c/w hex bolster	£2.05
AT01031	PH2 X 100mm c/w hex bolster	£2.40



### Reversible Stubby



- Dual ended blade with PZ2 point and slotted



Code	Description	List Price
AT01040	PZ2/6	£2.40



Also available - please ask...

Brands featured here...



Bit Adaptor



**Stanley Fat Max XL Tape**

5-33-886 5mtr/16ft £20.45  
 5-33-891 8mtr/26ft £23.22

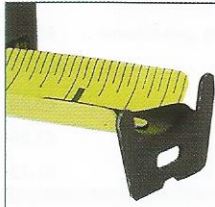

**Tru zero end hook**  
 - moves to compensate for accurate inside and outside measurements

**Specially designed hook grabs** on side, top or bottom for versatility measurements

**Cushion grip** provides sturdy, slip-resistant hold



**Wide 32mm blade** makes reading the numbers easy

**Mylar coated blade** is up to 10 times more resistant to abrasion than normal lacquered blades

**Huge standout of almost 4 metres** for easy one person measuring

**Blade Armor coating** on the first 150mm reduces the risk of breaking the tape by 95%

**Stanley Powerlock Tape**

0-33-523 3mtr/10ft £7.52  
 0-33-215 3.5mtr/12ft £8.99  
 0-33-553 5mtr/16ft £13.49  
 0-33-526 8mtr/26ft £17.49  
 0-33-443 10mtr/33ft £20.49

**Compact case** - easier to hold

**Belt clip** for ease of storage

**3-rivet end hook** for long life (excluding 3.5m)

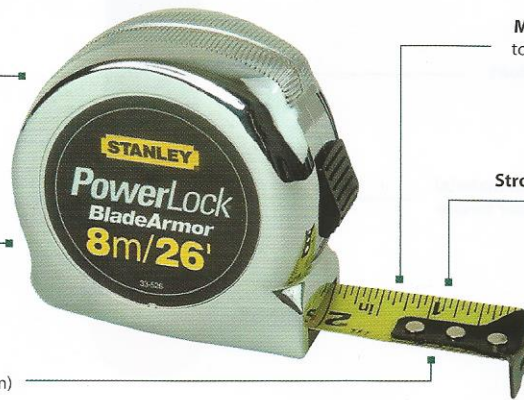

**Mylar coated blade** is up to 10 times more resistant to abrasion than normal lacquered blades

**Strong 25mm width blade** for large standout

**Blade Armor coating** on the first 100mm reduces the risk of breaking the tape by 95%

**Stanley Fat Max Blade Armor Tape**

0-33-719 5mtr/16ft £16.72  
 0-33-726 8mtr/26ft £20.43

**Cushion grip** provides sturdy, slip resistant hold

**Specially designed hook grabs** on side, top or bottom for versatility

**3-rivet end hook** 40% stronger than a 2 rivet hook construction



**Mylar coated blade** is up to 10 times more resistant to abrasion than normal lacquered blades

**Huge standout of 3.35m** for easy one person measuring

**Wide 32mm width blade**

**Blade Armor coating** on the first 100mm reduces the risk of breaking the tape by 95%

**Hardman Tape Measures**

**5mtr/16ft**  
 AT15001 £3.31

**8mtr/26ft**  
 AT15002 £6.00

**Rubber coated case** to provide non-slip surface for better handling

**Ergonomically shaped**



**Class II accuracy**

**Dual reading** English metric



### 1. Stanley Bi-Material Tape

- 0-30-686 3mtr/10ft £3.22
- 0-30-696 5mtr/16ft £5.23
- 0-30-656 8mtr/26ft £9.99
- 12.7mm Blade Width
- Tylon blade coating for wear resistance
- Matt finish blade

### 2. Lufkin Unilock Tape

- YU835CME 5mtr/16ft £10.84
- YU838CME 8mtr/26ft £16.28
- Lightweight High Strength Case
- Blade Lockout

### 3. Lufkin Diameter Tape

- W606PD 6ft £18.50
- W606PM 2mtr £18.50
- Designed to measure diameters of circular objects

### 4. Stanley FatMax Closed Steel Tape

- 0-34-132 30mtr/100ft £26.93
- 10mm Steel blade width
- High Impact ABS case
- Fast rewind 1 to 3

### 5. Stanley Powerwinder Open Frame Fibreglass Tape

- 2-34-771 30mtr/100ft £20.44
- 2-34-774 60mtr/200ft £29.72
- 2-34-776 100mtr/300ft £37.15
- 13mm blade width
- Fast rewind 1 to 3
- Durable and impact resistant case

### 6. Bosch Digital Angle Measure

- DWM40L £142.79
- Easy read LCD display
- Accuracy + or - 0.1°
- Ideal for staircase, roof truss, kitchen fitting

### 7. Stanley Rustless Steel Rule

- 0-35-400 6"/150mm £7.08
- 0-35-401 12"/300mm £11.90
- 1-35-402 24"/600mm £23.22
- 1-35-403 40"/1mtr £55.75
- Marked both sides
- One side imperial to 64ths and 100ths
- One side metric to 0.5mm

### 8. Hardman Stainless Steel Rules

- AT13001 6"/150mm £1.99
- AT13002 12"/300mm £2.99
- AT13003 24"/600mm £5.99
- AT13004 39"/1mtr £9.99
- AT13005 Folding 24" £4.99
- Dual Sided - imperial and metric scales
- Clear markings and graduations

### Leica Disto D2

D2 £129.00

Minimum / maximum measurements, tracking and storage of results makes your work much easier

Measuring range 0.05m up to 60m; typ. accuracy ± 1.5mm



- Illuminated 3-line display
- IP 54 - splash and dust proof
- Shortcut keys - easy to use and rapid access to frequently used functions

### Leica Disto D3

D3 £229.00

Measuring range 0.05m up to 100m; typ. accuracy ± 1.0mm (displayed to 1/10mm accuracy)



Tilt sensor (accuracy ± 0.3°) Measures angles up to ± 45° at the touch of a button



- Exact calculation of a room angle with only three measurements
- Horizontal distances can be measured without problem despite nearby obstructions with tilt sensor
- Flip-out end-piece with automatic detection

Also available - please ask...

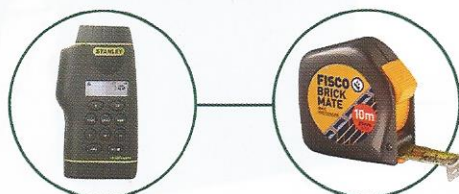

Sonic Measures

Brickwork Tapes

Brands featured here...



## Hardman Sack Truck

**AT05001** Truck  
List Price: £35.91

**AT05004** Spare Wheel  
List Price: £15.49



**P-Handle** for comfort and easier control

**Extra large toe plate** for greater load stability



**1" Heavy Duty bar construction**

**Heavy duty 4-ply treaded pneumatic tyres**

## Hardman 3 in 1 Sack Truck

**AT06001** Truck  
List Price: £70.24

**AT06002** Spare Wheel  
List Price: £8.25

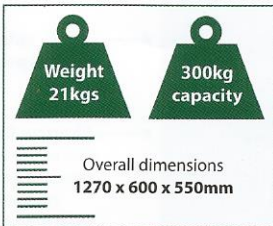

**Pull along 'flat bed' use**



**Includes rear castor wheels** for ease of movement and extra support

**Pneumatic tyres**

**Conventional upright use**



**400mm x 300mm loading plate dimensions**

**Extra support at 45°** for heavy load handling



**1" Heavy duty tubular steel construction**

## Stanley Fat Max Rolling Workshop

**1-94-210** List Price: £113.35

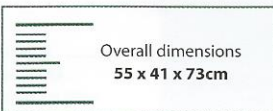

**Telescopic handle** for easy manoeuvrability

**Tool box with lift-out tray** for smaller tools, which fits neatly into the fold-out lid

**Large adjustable organiser** for nails, screws and other small components

**Opens easily into a 4 level workstation**



**Heavy duty road tested wheels**

**Giant lower bin** ideal for bulky materials and equipment such as paint cans, large components and power tools

**Ball bearing sides** for smooth opening even with heavy loads



1.



4.



7.



10.



2.



5.



8.



11.



3.



6.



9.



12.

- 1. Stanley Mobile Tool Chest**  
**1-92-083** 23" l x 14" w x 16" h  
 £47.22
- Easy transportation and storage for the larger tools
  - Wide telescopic steel handle
  - Soft side pocket organiser

- 4. Stanley Galvanised Toolbox**  
**1-92-211** 26" £36.06
- Heavy-duty toolbox with heavy duty metal latches
  - Rust resistant galvanised finish
  - Removeable tote tray
  - Lid contains intergrated saw groove for cutting timber, pipes and other material

- 7. Stanley Fatmax XL Round Top Toolbag**  
**1-93-955** 51 x 25 x 22cm £59.51
- Ply fabric construction - 1200 denier outer 600 denier inner polyprop central lining
  - Rigid waterproof plastic base

- 10. Stanley Hard Base Open Tote Bag**  
**1-93-951** 48 x 25 x 33m £29.75
- Heavy duty 600 denier fabric with leather reinforcements for long lasting durability
  - Rigid waterproof plastic base
  - Multiple use tool compartments

- 2. Irwin Professional Tool Box**  
**10503817** 26" £48.40
- Made of heavy-duty rainproof structure foam
  - Padlock ready with a built-in eye
  - Lid access storage which secures small parts

- 5. Stanley Professional Toolbox**  
**1-92-251** 20" £21.81  
**1-92-258** 26" £28.33
- Splash proof - Lockable
  - Removeable tote tray
  - Easy grab handle

- 8. Stanley Fatmax XL Open Tote**  
**1-93-957** 50 x 25 x 36cm £49.58
- 1200 x 1200 denier fabric for heavy duty uses
  - Injected polypropylene bottom for protection from moisture and dirt on the site

- 11. Stanley Fatmax Contractors Rig**  
**1-94-198** £69.43
- Heavy duty 600 denier fabric
  - Padded, adjustable belt and padded back on pouches
  - Removeable / interchangeable pouches & rustproof hammer loop

- 3. Stanley Fatmax Waterproof Toolbox**  
**1-93-935** 28" £37.77
- All round water seal
  - Portable tote tray
  - Structural foam construction

- 6. Stanley Jumbo Organiser Toolbox**  
**1-92-905** 16" £14.16  
**1-92-906** 19" £18.88  
**1-92-908** 22" £23.61
- Ideal for multiple tool storage with 2 removeable organisers

- 9. Stanley Fatmax XL Open Mouth Toolbag**  
**1-93-954** 44 x 25 x 22cm £45.21  
**1-93-956** 51 x 25 x 22cm £49.58
- Heavy duty 1200 denier fabric for long lasting durability
  - Rigid waterproof plastic base
  - Multiple use tool compartments

- 12. Hardman Toolbag**  
**AT87001** 24" £13.17
- Heavy duty polyester with side pockets and reinforced handles
  - Wide top opening for accessibility
  - c/w adjustable shoulder strap

Also available - please ask...



Organiser Trays



System Storage Case

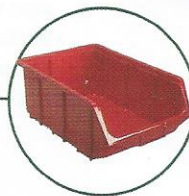

Storage Bins

Brands featured here...



**Hardman**  
 WORK TOUGH TOOLS



## Irwin Hilmor GLM Pipe Bender

GLM £84.07

- Compact bender with precision high pressure aluminium die cast formers and guides to produce sets, offsets, multiple bends etc in tubes of a maximum diameter of 22mm
- Ideal for installation of small heating systems
- Supplied complete with 15mm and 22mm formers and guides - for bending up to 90°
- The 15 and 22mm Formers also feature unique degree marks on the casting for 'at a glance' bend accuracy



## Monument Mini Pipe Bender

2611 £17.05

- For 180° bends on 6mm, 8mm and 10mm copper pipe



## Monument Tube Cutters

264Y Size 0 (22mm capacity) £11.20

265B Size 1 (28mm capacity) £15.80

266E Size 2a (43mm capacity) £17.35

TC3 Size 3 (82mm capacity) £58.00

### Spare Wheels

273A To fit all the above £1.60

- Made from zinc pressure diecast bodies
- All parts liable to wear are heat treated
- Fluted handles of sizes 1 and 2A are fitted with a spare wheel

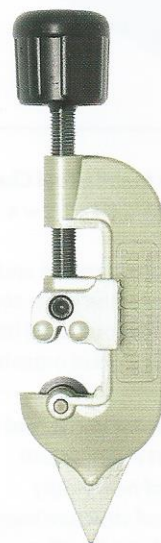

## Monument Pipe Cutter

15PC 15mm £8.90

22PC 22mm £9.70

- For work in confined spaces
- Strongly made outer ABS plastic casing houses the inside mechanism made from steel which takes the load of the cut
- Cuts copper pipes once the gate of the tool is closed over the pipe



## Monument Autocut Pipe Slice

1715C 15mm £12.70

1722Y 22mm £14.15

1728Q 28mm £19.45

269N Spare Wheels £1.70

- For work in confined spaces
- Cuts in one direction
- Only cut exact sizes of copper pipe specified
- Made from zinc pressure diecast bodies
- Not for use on stainless steel





**1. Soldering and Brazing Pads**  
**2350X** £12.55  
 • Woven glass fabric  
 • Professional quality  
**2348Q** £14.50  
 • Asbestos free heavy duty mat  
 • For protection of surrounding areas when soldering etc

**2. Monument Basin Wrench**  
**327R** £6.20  
 • The original "Shetack" basin wrench for fitting back nuts and union nuts of pillar and bath taps behind basins, baths and sinks

**3. Monument De-Burring Tool**  
**3020C** £3.05  
 • Disposable tool, ideal for de-burring copper pipe  
 • Swivelling blade rotates freely allowing many de-burring operations

**4. Monument Plastic Pipe Cutter**  
**2640E** 25mm £22.00  
 • Very effective on PVC, MDP, polybutylene, polyethylene plastic, plastic overflow pipe, mini trunking, rubber hose and many more

**5. Monument Gas Test Gauge**  
**257C** £14.90  
 • Made from tough plastics  
 • Used for testing pipework installations and for checking and setting correct gas pressures on domestic and commercial appliances

**6. Monument Adjustable Basin Wrench**  
**345V** £21.95  
 • Used for loosening and tightening nuts in awkward positions  
 • Teeth will grip uneven shapes  
 • Swivel head allows access where fixed spanners will not operate

**7. Monument Box Ring Immersion Spanner**  
**358J** £7.56  
**361T** £16.75  
 • Made with octagon at the base of the cylinder  
 • Enables really tight immersion heaters to be loosened

**8. Monument Stopcock Key**  
**339C** £10.30  
 • For turning stopcocks on and off  
 • Turning handle has one chisel end for lifting covers

**9. Lead Dressing Tools**  
**734D** 2" £11.00  
**735G** 2.1/4" £12.95  
 • Specially designed for use on Sheet lead, Copper, Zinc, Aluminium etc  
 • Made with sufficient lift to clear users knuckles

**10. Bernzomatic Blowtorch**  
**TS1100E** £22.07  
 • Trigger start / self ignition  
 • Flame control up to 1750°C

**11. Gas Cylinders Hot Weather Use**  
 (Butane)  
**B175-E** 175g £2.54  
**B330-E** 330g £3.82

**Cold Weather Use**  
 (Propane / Butane)  
**PB190-E** 190g £1.65  
**PB175-E** 175g £2.67  
**PB330-E** 330g £3.82

**12. Tallow**  
**261P** Small £2.55  
**262S** Medium £5.00  
**263V** Large £24.15  
 • Used as a lubricant for threading, pulling electric cables through conduit etc

Also available - please ask...



Master Plunger



Tap Reseater



Bending Springs

Brands featured here...

**MONUMENT TOOLS**

**IRWIN**  
 Industrial Tools

**BERNZOMATIC**

## Vitrex 'Big Clinker' Tile Cutter

100600 £135

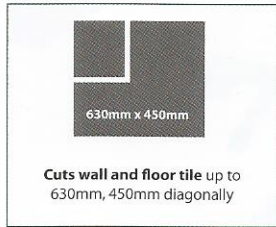

**Multi purpose cutter** for most tile including ceramic and porcelain

**Adjustable English and metric measuring guide** provides accurate repeat cuts

**Wide die cast aluminium alloy base** with heavy duty rubber pads for cutting stability

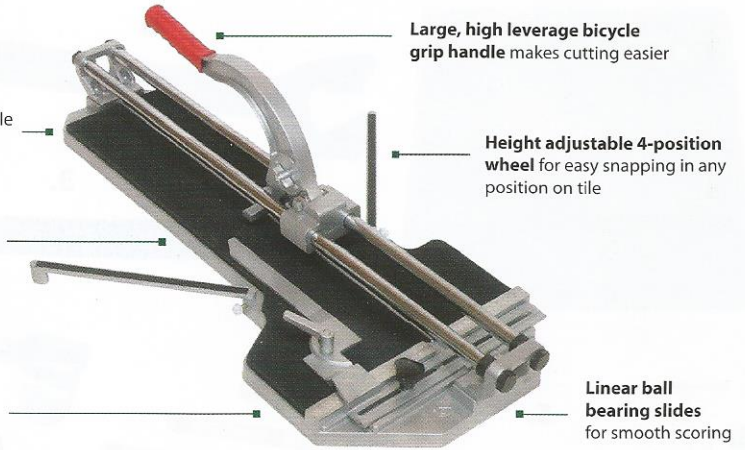

## Vitrex Professional Tile Cutter

102750 £57.63

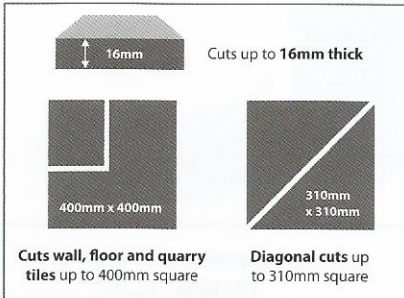

**Large 'Soft Grip' handle**

**Tungsten Carbide cutting wheel** 22mm

**With integral angle cutting guide and linear bearings** for easy, accurate cuts

**Heavy duty steel flat bed tile cutter**

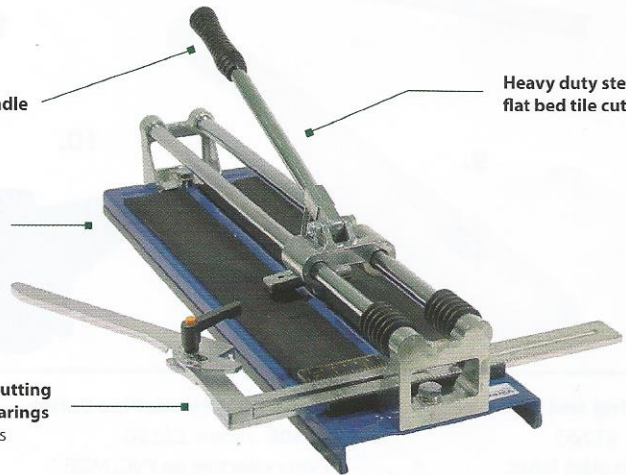

## Vitrex Professional Diamond Blade Wetsaw 180mm Blade

103413 240v £69.56

103414 110v £76.84

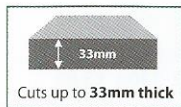

**180 x 16mm diamond blade** with continuous rim for extra clean cut

**Integral ruler and adjustable rip guide** for perfect straight cuts

**Direct drive** produces a constant cutting speed for ultra smooth cuts

**Flip-up steel table top** for 15°, 30° and 45° mitres

**Thermal overload protection** to prevent overheating

**Fully adjustable mitre guide** with unique ratchet mechanism



## Vitrex Portable Diamond Blade Wetsaw 100mm Blade

103402 240v £38.14

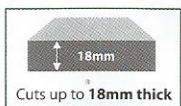

**100 x 16mm diamond blade** with continuous rim for extra clean cut

**Thermal overload protection** to prevent overheating

**Flip-up steel table top** for 15°, 30° and 45° mitres

**Fully adjustable mitre guide** with unique ratchet mechanism







**1. Vitrex Hard Tile Drill Bits**

- 102791 6mm £5.74
- 102792 8mm £6.72
- 102793 10mm £7.68
- 102794 12mm £8.63
- 102795 15mm £10.07
- 102796 18mm £11.51
- 102797 22mm £12.95
- 102798 25mm £14.39
- 102799 32mm £16.79
- 102800 38mm £19.20

- Diamond grit edged bit, ideal for drilling hard tiles
- Slotted bit design for easy waste removal
- Suitable with most power drills
- Suitable for use with porcelain, granite, quarry, stone, marble, terracotta, ceramic
- Must be used in conjunction with Vitrex Universal hard tile drill bit guide (No.3) and Water cooling system (No.2)

**3. Vitrex Universal Hard Tile Drill Bit Guide**

- 102788 £23.53
- Roller bearing system for stability and accuracy
- Ideal solution for drilling hard tiles
- Use in conjunction with hard tile drill bits
- Fully adjustable frame

**4. Vitrex Continuous Rim Diamond Blade**

- 103407 180mm £23.01 (Fits 103413/414)
- 103409 100mm £12.44 (Fits 103402)
- Cuts quarry tiles, slate, stone, marble, ceramic, terracotta, concrete and masonry
- Continuous rim allows for cleaner cut

**5. Vitrex Tile Nippers**

- 102430 £13.34
- Tungsten Carbide tipped jaws, ideal for awkward shaping

**6. Vitrex Profile Gauge**

- 101030 150mm £12.13
- 101033 200mm £12.86
- 102461 300mm £19.78
- Quick and easy way to copy awkward shapes

**7. Vitrex Premium Grout Float**

- 102900 £12.76
- For fast even grouting of large areas

**8. Vitrex Adhesive Trowel**

- 102957 6mm £7.90
- 102909 10mm £7.90
- Square Notch
- Stainless Steel Blade

**9. Vitrex Tile and Glass Drill**

- 102756 6mm £4.64
- 102760 10mm £7.61
- Tungsten Carbide Tip
- For drilling tile and glass

**10. Vitrex Heavy Duty Tile Cutter**

- 101490 £7.90
- Scoring and snapping ceramic tiles up to 10mm thick

**11. Vitrex Tile Spacers**

- 102152 1.5mm (500) £2.46
- 102251 2.5mm (250) £1.97
- 102252 2.5mm (500) £3.25
- 102051 5mm (250) £3.25
- 102052 5mm (500) £5.43
- The easy way to achieve a more professional finish
- Ensures an even grout line throughout

**2. Vitrex Water Cooling System**

- 102790 £7.20
- Prevents drill bit damage through overheating
- For use with hard tile drill bits

Also available - please ask...

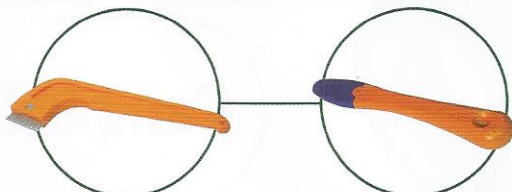

Grout Rake

Sealant Smoother

Brands featured here...

**Vitrex**   
The professional way to do it yourself

### Campbell Welded Round Link Chain

<b>033-2007</b>	2mm x 22mm x 8mm	60mtr reel	£105.18
<b>033-3007</b>	3mm x 26mm x 12mm	60mtr reel	£115.34
<b>033-4007</b>	4mm x 32mm x 16mm	58mtr reel	£143.05
<b>033-5007</b>	5mm x 35mm x 20mm	32mtr reel	£120.61
<b>033-6007</b>	6mm x 42mm x 24mm	28mtr reel	£143.87
<b>033-7007</b>	7mm x 48mm x 28mm	26mtr reel	£174.46
<b>033-8007</b>	8mm x 52mm x 32mm	20mtr reel	£121.13

- Electro galvanised and blue chromed
- Inside/outside use

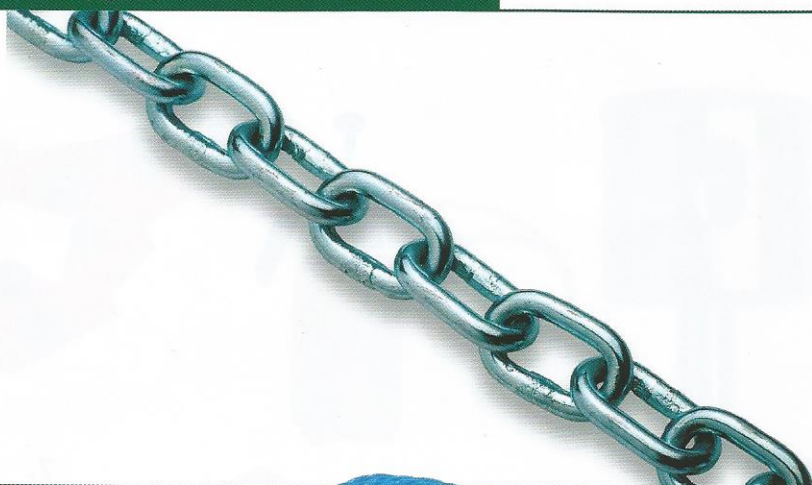

### Cardoc Blue Film Rope Coils

<b>6mm diameter x 30mtr</b>	£5.10	<b>6mm diameter x 220mtr</b>	£18.26
<b>8mm diameter x 20mtr</b>	£7.50	<b>8mm diameter x 220mtr</b>	£33.78
<b>10mm diameter x 15mtr</b>	£7.10	<b>10mm diameter x 220mtr</b>	£47.79
<b>12mm diameter x 10mtr</b>	£7.50	<b>12mm diameter x 220mtr</b>	£71.76

- Polypropylene General Purpose Rope
- For a multitude of uses around the home and workplace



### Wagon Rope

**WR27** 10mm x 27mtr £12.95

- Polypropylene Film



### Barrier Tape

**70mm x 500mtr** £10.50  
Black/Yellow

- Non adhesive, strong and durable PVC tape
- For cordoning off areas



### Hazard Warning Tape

**50mm x 33mtr** £4.00  
Black/Yellow

- Adhesive backed
- For marking hazardous areas



### Brown Parcel / Opp Tape

**48MMX66MT** £0.99  
Brown

- Self adhesive for parcels and packages



### Campbell Quick Links

**0983672** 5mm £5.43  
**0983674** 8mm £3.18

- Quick link
- Electro galvanised

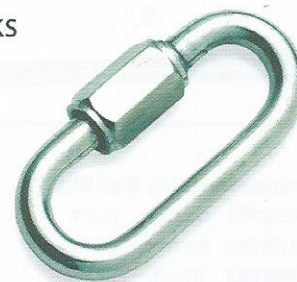

### Sterling Boron Steel Security Chain

**809** 0.9mtr £12.38  
**812** 1.2mtr £16.52  
**815** 1.5mtr £20.64

- Case hardened square link chain
- Hacksaw and bolt cropper resistant
- Weather resistant



Brands featured here...

**Campbell®**

**Sterling**

## Hardman Cable Reels

- AT42035** 25mtr/110v/16amp £47.86
- AT42037** 50mtr/110v/16amp £65.43
- AT42036** 25mtr/240v/13amp £32.94
- AT42038** 50mtr/240v/13amp £52.86

- Complies with BS5733
- 1.5mm<sup>2</sup> Cable
- Safety cut out switch
- German manufacture
- Robust PVC drum



**1. Brennenstuhl Garant Cable - Management Reel**

- 1218053** £39.25  
25mtr/240V/13A
- 1208063** £58.50  
50mtr/240V/13A
- Reel body made of special break resistant Breflex plastic
- New cable guide handle for precise winding

**2. Hardman Cassette Reels**

- AT42015** £24.46  
9mtr/110v/13amp
- Twin Socket
- Robust pvc case
- AT42046** £17.11  
10mtr/240v/13amp
- Complete with thermal overload cut out
- Triple Socket
- Robust pvc case

**3. Hardman Transformer**

- AT45010** 3.3KVA £68.75
- 16amp rated
- Twin outlet
- Weatherproof comes with 2mtr cable

**4. Hardman Extension Cable**

- AT42050** £16.83  
14mtr / 110v
- 16amp rated
- Weatherproof sockets
- 1.5mm HD cable
- German Manufacture

**5. Hardman Weatherproof Plugs & Couplings**

- AT42022** 110v Plug £2.22
- AT42023** 110v Coupling £3.23

**6. Hardman Junction Splitter Box**

- AT42021** 5mtr £33.54
- 4 way / 110v / 16amp
- Weatherproof sockets

**7. Hardman Circuit Breaker RCD**

- AT42025** 240v £15.08
- Instant mains cut-off for domestic power tools

**8. Hardman Trailing Socket**

- AT42003** £10.77
- 13 amp/4 point/Anti Surge
- Anti surge radio-frequency

**9. Hardman Power Block**

- AT42027** 1.5mm cable £39.94
- AT42028** 2.5mm cable £46.86
- 14mtr/110v 4 way junction box
- Comes in break-resistant plastic housing
- 2 hanging hooks
- By Brennenstul

Also available - please ask...



VDE Tools Available

Brands featured here...



### All Metal No2 Taper Mouth MYD Handle

The tool of choice for heavy industrial and contracting work

**Hardman**  
AT56002 £15.74

**Bulldog**  
5TM2AM £20.89

The metal handle provides extra strength and wooden cross piece allows for comfort and grip

Hot double roll formed from one single piece of best quality steel

The solid socket is forged as an integral part of the blade

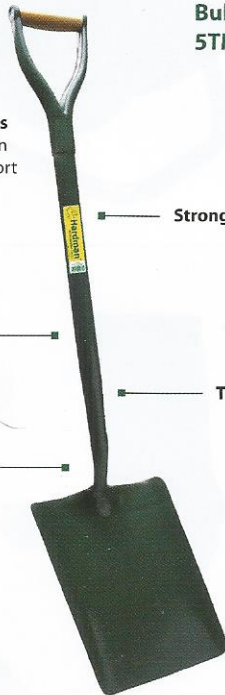

Strongest shovel available

Tubular steel shaft

### All Metal No2 Square Mouth MYD Handle

The tool of choice for heavy industrial and contracting work

**Hardman**  
AT56001 £15.74

**Bulldog**  
5SM2AM £20.89

The metal handle provides extra strength and wooden cross piece allows for comfort and grip

Hot double roll formed from one single piece of best quality steel

The solid socket is forged as an integral part of the blade



Solid forged square mouth shovel

Tubular steel shaft

Used for trench work, concrete mixing, working tarmac & shovelling

### All Metal Draining MYD Handle

Suitable for heavy duty and contracting work

**Hardman**  
AT56004 £21.63

**Bulldog**  
5NDAM £26.60

All steel solid socket construction

Hot pressed from hot rolled heavy gauge carbon steel

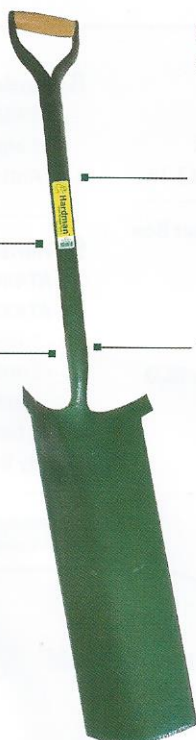

Used for digging holes, deep narrow trenches, cable channels, pipe channels, drain channels or post holes

Tubular steel shaft

### Open Socket No2 Square Mouth Plastic D Handle

The ideal tool for shovelling out or backfilling trenches, concrete mixing, working tarmac and moving cement, chippings etc.

**Hardman**  
AT56003 £10.93

**Bulldog**  
2SM2PD £12.54

The polypropylene handle provides greater comfort and is weatherproof

Hot pressed from hot rolled heavy gauge carbon steel

The open socket shovel is used for moving loose earth, sand, grain and gravel



Hardwood shaft

Designed with the usual Bulldog attention to detail but aimed at the budget conscious contractor

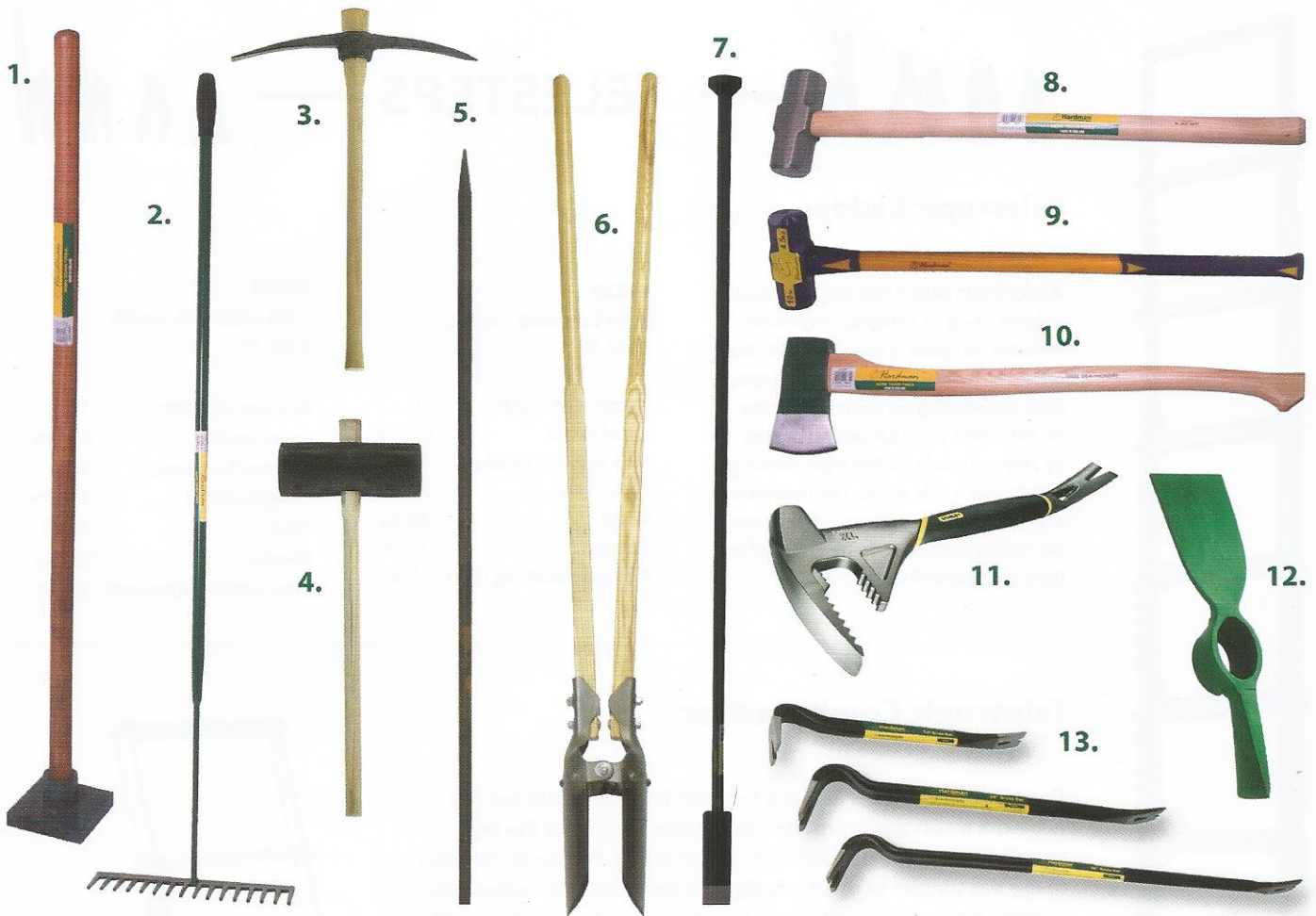

**1. Hardman Earth Rammers**  
**AT57006** Wood Shaft £21.20  
**AT57007** Metal Shaft £22.80  
 • For compacting tarmac or earth

**2. Hardman Rakes**  
*Asphalt*  
**AT57009** Wood Shaft £17.55  
**AT57010** Metal Shaft £17.55  
*Tarmac*  
**AT57011** Wood Shaft £18.00  
**AT57012** Metal Shaft £20.13  
 • Tubular steel or wooden shaft  
 • The reinforced shank means improved durability  
 • Tarmac rake has round tines  
 • Asphalt rake has flat tines

**3. Hardman Chisel/Point Pick**  
**AT48010** Head only £8.85  
**AT48020** Hickory shaft £12.14  
 • Solid forged  
 • Rugged performance

**4. Hardman Paviers Mauls**  
**AT20040** £33.00  
 • Rubber head c/w shaft  
 • Ideal for laying paving stones

**5. Hardman Crowbars**  
**AT57020** 48" x 1" £14.20  
**AT57021** 60" x 1.1/8" £20.70  
**AT57022** 72" x 1.14" £28.35  
 • Solid forged  
 • Chisel and point  
 • Hardened and tempered

**6. Hardman Post Hole Digger**  
**AT57005** £25.65  
 • Solid forge blade  
 • Designed to dig out deep post holes  
 • Twin handled wooden shafts  
 • Sturdy construction

**7. Hardman Post Hole Digger Bar - Wooden Handle**  
**AT57023** £26.48  
 • Wooden Handle - 17lb weight

**8. Hardman Sledge Hammer**  
**AT20025** 7lb £25.89  
**AT20026** 10lb £27.11  
**AT20027** 14lb £32.71  
 • Hickory shaft  
 • Ground striking faces

**9. Hardman Fibre Glass Sledge Hammer**  
**AT20030** 7lb £28.46  
**AT20031** 10lb £31.93  
**AT20032** 14lb £42.14  
 • Shock absorbant fibreglass shaft

**10. Hardman Felling Axe**  
**AT22001** 3.1/2lb £17.30  
**AT22002** 4.1/2lb £24.37  
 • Shock absorbant hickory handle  
 • Ground head

**11. Stanley Fatmax XL Fubar**  
**9-55-099** £33.74  
 • One piece forged steel bar pry bar-nail puller-hammer in one

**12. Hardman Mattock**  
**AT48013** £8.85  
 • 5lb Grubbing mattock head  
 • Solid forged  
 • Rugged performance

**13. Hardman Brute Bars**  
**AT49001** 14" £3.61  
**AT49002** 24" £8.33  
**AT49003** 36" £11.44  
 • Wider chisel blade offers increased anchorage and strength  
 • Heat treated, forged steel for a more robust, durable bar

Also available - please ask...



Rigger Gloves



Post Hole Driver

Brands featured here...





## TELESTEPS

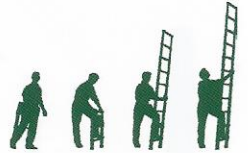

### Telescopic Ladder

A telescopic ladder can help you reach heights of up to 5 metres, anywhere. Virtually no space is too confined - the retracted ladder is just 0.78 - 1.1 metres high, depending on the model. It can be extended to its full length or step by step, so you have the right working height and a safe angle. The hardwearing aluminium tubes and perfect fit ensure the ladder has the stability required for daily professional use.

#### 60233

3.3m Extended Length  
£147.78

Number of treads	10
Tread width	65mm
Max working height	4.4m
Length closed	78cm
Width	49cm
Weight	10.7kg
Max Safe Working Load	150kg

#### 60838

3.8m Extended Length  
£165.17

Number of treads	12
Tread width	65mm
Max working height	5.0m
Length closed	110cm
Width	51cm
Weight	12.8kg
Max Safe Working Load	150kg

### Telescopic Combi Ladder

The new Combi Ladder acts as a free-standing stepladder, but has two extra treads which provide comfortable support for the legs, enabling you to stand steady and work at height. You decide whether to use this support or use the ladder as a traditional stepladder. With a simple manoeuvre the ladder is transformed and is equally suitable for leaning against a wall. One retractable Combi Ladder instead of three unwieldy ladders.

#### 60617

1.7m Extended Length  
£173.87

Number of treads	4+2
Tread width	90mm
Max working height	3.0m
Length closed	68cm
Width	62cm
Weight	10kg
Max Safe Working Load	150kg

#### 60630

3.0m Extended Length  
£260.82

Number of treads	8+2
Tread width	90mm
Max working height	4.2m
Length closed	79cm
Width	77cm
Weight	19.8kg
Max Safe Working Load	150kg

#### 60623

2.3m Extended Length  
£226.04

Number of treads	6+2
Tread width	90mm
Max working height	3.6m
Length closed	73cm
Width	69cm
Weight	14.5kg
Max Safe Working Load	150kg



## Fixed Telescopic Loft Ladder

While conventional Loft Ladders have to be folded and stored in the attic, the Telesteps collapsible Loft Ladder is hidden away in the ceiling. It is an elegant and incredibly compact Loft Ladder that saves you attic space and fits into a very small hatch opening. It is available in several models for different ceiling heights.

**60324**  
Loft Ladder Mini  
£147.78

Ceiling Height 2.35-2.45m  
Min. hatch opening 520 x 600mm  
Tread width 90mm  
Weight 12.5kg



**60927**  
2.3m Extended Length  
£156.48

Ceiling Height 2.65-2.93m  
Min. hatch opening 520 x 920-1100mm  
Tread width 90mm  
Weight 15.3kg

## Working Platform

A platform for several work levels. Portable with one hand. A robust work platform has a host of benefits for anyone who often works at height for long periods. The telescopic solution enables you to vary between three levels. A unique benefit which spares your shoulders and back.

**61209**  
Telescopic Work Platform  
£199.95

Platform Area 1365 x 410mm  
Working Height 2080 / 1880 / 1700mm  
Adjustable Heights 880 / 680 / 500mm  
Width 620mm  
Weight 17.4kg  
Safe Working Load 150kg



## AUTOSTEPS™

Patented automatic close-down

- AUTOSTEPS™ patented automatic close-down.
- Easily portable, with telescopic retraction.
- Minimum turning radius in confined spaces.
- Automatic locking - clearly visible markers under each tread.
- Certified to EN 131-SP, TUV/GS, NEN2484 etc.
- Adjustable to different heights - several ladders in one.
- Always a safe angle thanks to the flexible length.
- Innovative accessories for greater flexibility and safety.
- Wide treads for comfort during long work sessions.
- High quality for professional use.
- Telesteps' uniquely strong aluminium alloy enhances safety.
- Patented, world-leading design.

## 2.0mtr Non-Conductive Ladder

- The choice for those working in an electrical powered environment
- Voltage tested in accordance with the European standard EN61478 to withstand voltages of 30 kV
- Can be used as a free standing combination ladder or as a leaning wall ladder
- Weight - 9.3kg



**61520** £283.43

## Top Supports

- Fits all Telesteps lean-to ladders (3.3 and 3.8m)



**9160** £49.53

## Adjustable Safety Feet

- Adjustable height 0-225mm
- Fits all Telesteps lean-to ladders (3.3 and 3.8m)
- Supplied in pairs



**9170** £39.08

## Ground Spike

- Fits all safety feet
- Supplied in pairs



**9142**  
£8.65

## Safety Feet (Pairs)

- To suit wooden ladders



**9173**  
£26.04

Also available - please ask...

Brands featured here...



Red Line Ladder



Working Tray



Carry Bag



## Hardman Site Lights

### Twin Head

**AT43001** 500W/240V  
List Price: £31.69

**AT43005** 500W/110V  
List Price: £32.77

### Single Head

**AT43010** 500W/240V  
List Price: £23.31

**AT43012** 500W/110V  
List Price: £24.03

Suitable for indoor or outdoor use

Supplied with 2.9 metres of cable of & approved plug

Adjustable tripod constructed from tough tubular steel (extends from 78cm-183cm)

IP 55  
rated



Toughened glass & wire safety guard

Powerful high intensity brilliant beam

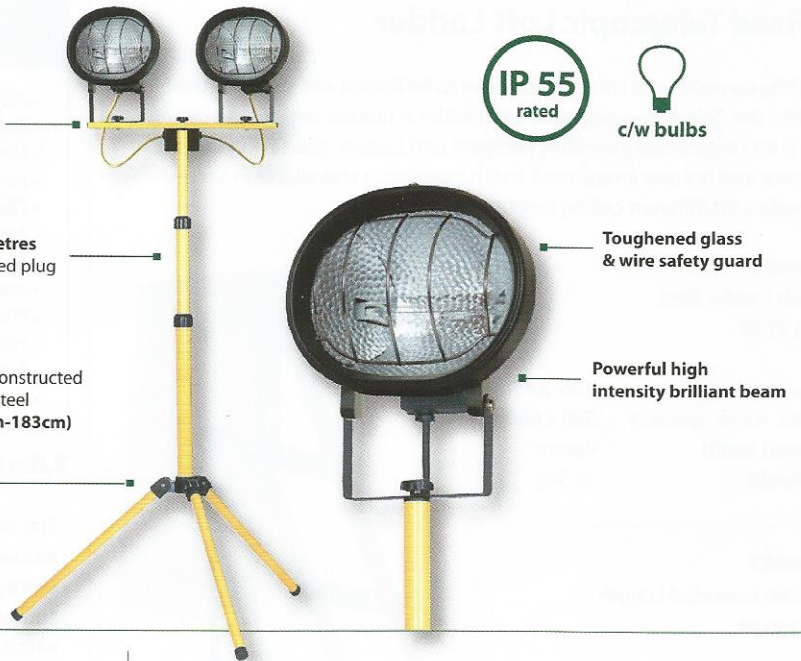

## Hardman Single Portable Lights

**AT43015** 500W/240V  
List Price: £12.66

**AT43017** 500W/110V  
List Price: £14.11

- Comfortable padded carrying handle
- Toughened glass with wire guard
- High intensity haogen tube

IP 55  
rated

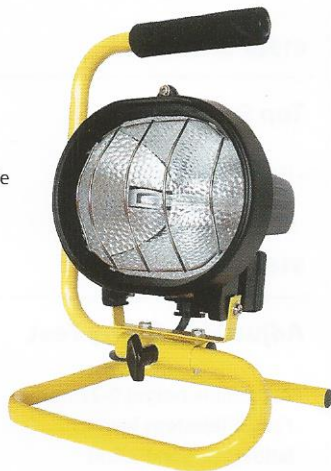

## Hardman Fluorescent Plasterers Light

**AT43054** 24" 110V  
List Price: £48.13

**AT43053** 18W Tube  
List Price: £1.00

- Fluorescent floor standing tripod light
- 110V can be linked in series
- Suspension hook for versatility

IP 65  
rated



## Brennenstuhl Low Energy Jet Light

**1172563** 36W/240V  
List Price: £44.87

**1172563** 36W/110V  
List Price: £44.87

- Can be used in three positions - standing, suspended or lying flat
- Compact, strong waterproof casing



Equivalent to  
200W bulb



## Brennenstuhl Site Light

**1172033** 240V/200W  
List Price: £63.25

**1172333** 110V/200W  
List Price: £72.38

- Power takeoff
- Inbuilt triple socket (240V)
- Impact resistance casing and polycarbonate lens



With 200W bulb  
and bulb holder







**1. Hardman Task Light**  
**AT42030** 240V/38W £26.88  
**AT42031** 110V/38W £31.75

- Power Take Off
- Light remains cool in use
- Freestanding or mounting hook

**2. Hardman Mini Portable Lights**  
**AT43020** 150W/204V £8.97

- Powerful D.I.Y lighting
- IP55 Rated

**3. Hardman Inspection Lamps**  
**AT45001** 230V/100W £13.71  
**AT45002** 110V/100W £17.89

- Rubberised grip
- Comes 5 metres of cable

**4. Hardman Grip Type Inspection Lamps**  
**AT45005** 230V/60W £13.51  
**AT45006** 110V/60W £12.57

- Self grip feature
- Comes with 5 metre cable

**5. Unilite Floating Lantern**  
**UK46** £20.39

- Durable Rubber Casing
- 150% Brighter Xenon Bulb

**6. Unilite Rechargeable Lantern**  
**UK240** £38.75

- Lightweight, high impact casing - c/w battery & charger

**7. Unilite Floating Lantern**  
**UK49V** £11.21

- Co polymer durable waterproof casing

**8. Brennenstuhl Headlight**  
**1179770** £8.53

- 4 settings - 6 Superbright LED bulbs & 1 xenon bulb

**9. Brennenstuhl Rechargeable Hand Lamp**  
**1175343** 40W £31.10

- 28 Extra bright led bulb
- 45 hours constant use when charged
- c/w battery and charging unit

**10. Brennenstuhl Low Energy Lamp**  
**1177183** 240V £13.10  
**1177183** 110V £16.45

- Fitted with energy saving bulb
- Water oil resistant to IP44
- c/w 5metre cable

**11. 6 Volt Square Battery**  
**BAT6V** £1.10

- Economical battery for volume usage

**12. Duracell 'Plus' Batteries**

AAA	Card of 4	£3.32
AA	Card of 4	£3.32
C	Card of 2	£2.78
D	Card of 2	£2.78
PP3	Card of 1	£2.78

- Advanced performance
- 15v, alkaline

**13. Brennenstuhl LED Torches**  
**1175840** Mini 3AG13 £3.30  
**1175860** AAA £7.68  
**1175880** AA £13.16  
**1175920** C £29.60

- Prolonged endurance -10 times longer than bulb
- Solid aluminium housing

Also available - please ask...



DIY Inspection Lamp



Bulk Head Light (Black)

Brands featured here...



**1. Sterling Disc Padlocks**

- SPL080** 60mm £8.44  
**SPL100** 70mm £9.06  
**SPL120** 90mm £28.36  
*\*Available in Keyed Alike*
- Laser welded stainless steel lock body/brass cylinder
  - Hardened steel chrome plated closed shackle
  - Anti-drill plate on cylinder (70mm & 90mm)
  - Stainless steel interior

**2. Sterling Combination Padlocks**

- CPL120** 20mm (3 dials) £4.48  
**CPL130** 30mm (3 dials) £5.94  
**CPL140** 40mm (4 dials) £7.54  
**CPL151** 50mm (4 dials) £14.08
- Ideal for luggage, lockers and many other uses
  - 3 or 4 Digit dial code

**3. Sterling Laminated Padlocks**

- LPL132** 30mm £3.52  
**LPL142** 40mm £4.70  
**LPL152** 50mm £6.62  
**LPL162** 60mm £8.96
- Steel laminated body
  - Hardened steel chrome plated shackle
  - Brass cylinder

**4. Sterling Brass Padlocks**

- BPL122** 20mm £2.56  
**BPL123** 25mm £3.28  
**BPL132** 30mm £4.34  
**BPL142** 40mm £5.64  
**BPL152** 50mm £8.80  
**BPL162** 60mm £12.84  
**BPL242** Long Shackle £6.18
- Anti-Corrosion Brass Body
  - Hardened steel shackle
  - \*Available in Keyed Alike*

**5. Sterling Hasps & Staples**

- EHS075** 75mm £2.16  
**EHS095** 95mm £3.06  
**EHS115** 115mm £3.78  
**EHS135** 135mm £5.02  
**EHS155** 155mm £5.84
- Corrosion resistant
  - Hardened steel staple
  - Complete with fixings

**6. Sterling Shutter Locks**

- ASP160** 62mm £24.02  
**ASP180** 82mm £29.50  
**ASP190** 91mm £32.20
- \*Available in Keyed Alike*
- Solid brass body with hardened steel armour
  - Hardened steel chrome plated shackle
  - Hardened steel ball bearing locking mechanism

**7. Sterling Marine Padlock**

- MPL132** 30mm £8.34  
**MPL142** 40mm £10.64  
**MPL152** 50mm £15.92
- \*Available in Keyed Alike*
- Salt spray tested
  - Corrosion resistant
  - Stainless steel shackle

**8. Sterling Closed Shackle Padlocks**

- CSP142** 40mm £9.60  
**CSP152** 50mm £17.70  
**CSP162** 60mm £23.34
- \*Available in Keyed Alike*
- Solid brass chrome plated body
  - Hardened steel chrome plated shackle
  - Ball bearing locking

Also available - please ask...

Brands featured here...



Double Loop Cables



Key Cabinet

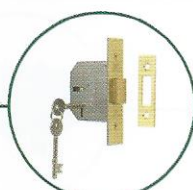

Deadlocks



## Rocol Permanent Spot Marking Paint (750ml)

Code	Description	List Price
43080	General Marking (White)	£6.99
43081	General Marking (Yellow)	£6.99
43082	Water (Blue)	£6.99
43083	Electricity (Red)	£6.99
43084	Cables (Green)	£6.99
43085	Deletes Existing Markings (Black)	£6.99

Touch Dry Available in 6 colours



- High definition, quick drying spot marking paint
  - Ideal where spot markings are required to last three months
  - Environmentally safe and low VOCs
  - Ideal for highway and grounds maintenance, highlighting pot holes and other obstructions prior to repair
- \* Duration may vary depending on surface conditions, weather, paint thickness and traffic levels - test in a small area before use*



## Rocol Easyline Edge Aerosol Paint (750ml)

Code	Description	List Price
47000	General Marking (White)	£25.85
47001	Caution Hazard (Yellow)	£25.85
47002	Danger/Prohibited (Red)	£26.55
47003	Mandatory/Protection (Blue)	£26.55
47004	Information/Direction (Green)	£26.55
47005	Chemical Storage (Orange)	£26.55
47006	Deletes Existing Lines (Black)	£26.55
47007	Deletes Existing Lines (Grey)	£26.55
47008	Fluorescent Pink	£26.55
47009	Fluorescent Yellow	£26.55

- Highly durable 'traffic grade' epoxy paint
  - Ideal for marking factory floors, car parks, stores and warehouses etc
  - Dries in 10 minutes, reducing 'down time'
  - Safe, non-toxic formula
  - Also suitable for stencilling / free hand marking
  - Paint lines last 2 times longer than the leading competitor\*
- \* Tested using internationally recognised ASTM D4060-95 using a Test Abraser*



## Rocol Temporary Spot Marking Paint (750ml)

Code	Description	List Price
43030	General Marking (White)	£11.44
43031	General Marking (Yellow)	£11.44
43032	Water (Blue)	£11.44
43033	Electricity (Red)	£11.44
43034	Cable (Green)	£11.44
43035	Telecommunications (Black)	£11.44

- Touch dry in 5 minutes
  - Specially formulated to provide high opacity lines and spot markings which can be immediately removed with water and a brush
  - Paint will also weather away naturally after four to six weeks
- \* Duration may vary depending on surface conditions - test in a small area before use*

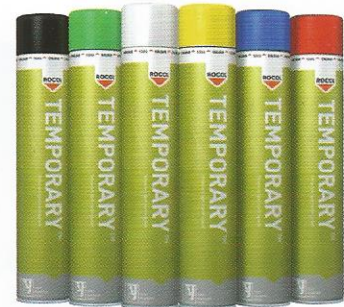

## Rocol Easyline Edge Line Marking Applicator

47010 £155.93

- Battery powered airflow system produces a sharp clean line
- Only use with Easyline Edge Aerosol Paint
- One applicator produces 3 line widths - 50mm, 75mm, 100mm
- Adjustable rear wheels allow line marking close to walls and racks
- For internal and external use
- Quick to assemble and simple to use
- Storage case, battery and spare masking plates are included



Spare Masking Plates  
47011 £6.87

- Removable for cleaning or can be replaced
- Two sets of plates with each new applicator



Brands featured here...



## Hardman Hi-Vis Range

### Hi-Vis Highway Jacket (EN471)

<b>AT58010</b>	M	£18.00
<b>AT58011</b>	L	£18.00
<b>AT58012</b>	XL	£18.00
<b>AT58013</b>	XXL	£17.87



### Hi-Vis Polo Shirt (EN471)

<b>AT58037</b>	M	£8.27
<b>AT58038</b>	L	£8.27
<b>AT58039</b>	XL	£8.27
<b>AT58040</b>	XXL	£8.27

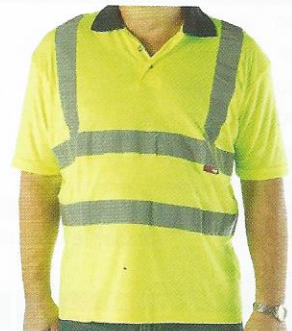

### Hi-Vis Waistcoat (EN471)

<b>AT58014</b>	M	£2.27
<b>AT58015</b>	L	£2.27
<b>AT58015A</b>	XL	£2.27
<b>AT58015B</b>	XXL	£2.27



### Hi-Vis Bomber Jacket (EN471)

<b>AT58029</b>	M	£18.00
<b>AT58028</b>	L	£18.00
<b>AT58027</b>	XL	£18.00
<b>AT58026</b>	XXL	£18.00



## Hardman Boots

### Leather Derby Safety Boots

(Sizes available 6-12)

<b>AT584-HONEY</b>	£37.37
<b>AT583-BROWN</b>	£35.40
<b>AT582-BLACK</b>	£33.43

- Conforms to CE EN20345 S3 Specification
- Steel midsole and toecap
- Antistatic - Cushion Insole



### Leather Rigger Boots

(Sizes available 6-12)

<b>AT581-TAN</b>	£28.20
------------------	--------

- Conforms to S2004 - CE EN20345SIP Specification
- Fur lined Antistatic - Cushion Insole
- Steel midsole and toecap



## Hardman Workwear

### Soft Shell Jacket

**18 MAIN** £ POA



### New Ohio Jacket

**18 OHIO** £ POA

- Bomber jacket, Navy polyester fabric outer shell
- Fleece lining, concealed hood with drawcord



### New Combat Trousers

**18 OHIO** £ POA

- Polyester/cotton multi pocket combat style trouser
- Button fastening with zip fly
- Available in navy, black and navy c/w 2 bands of 50mm reflective tape





- 1. Hardman First Aid Kits**  
**AT60001** 10 Person £13.50  
**AT60002** 20 Person £25.50  
**AT60003** 50 Person £37.50  
 • Comprehensive range of surgical dressings and supplies  
 • Ideal for workplace / home use
- 2. Vitrex Heavy Duty Knee Pads**  
**302459** £10.81  
 • Durable waterproof foam pads, with thick soft breathable liner
- 3. Irwin Pro All Terrain Knee Pads**  
**10503831** £18.44  
 • Adjustable sizing straps  
 • Non marking pads  
 • Convex caps allowing for freedom of movement
- 4. Safety Helmets**  
**White/Blue/Yellow**  
**AT58044-48** £5.00  
 • To EN397 specification

- 5. Grippa Gloves** £1.78  
 • Latex coated palm - non slip grip  
 • Ideal for building projects
- 6. Yellow Criss Cross Latex Gloves**  
 £1.08  
 • Knitted glove with inlaid rubber for non slip facility on glass/metal
- 7. Vitrex Thermal Gloves**  
**302111** £4.47  
 • Specifically designed for cold weather wear in construction trade  
 • Maintains gripping capability  
 • Durable - tear/puncture resistant  
 • Washable with latex coated palm for non-slip grip

- 8. Canadian Rigger Gloves**  
**TG6** Light Duty £0.80  
**TG6S** Heavy Duty £1.80  
 • General protection for heavy work
- 9. PVC Gloves - Knit Wrist**  
**Size 81/2** £1.10  
**Size 91/2** £1.89  
 • Resistant to oil and grease and household chemicals
- 10. Irwin Fingerless Carpenters**  
**10503828** Large £17.47  
**10503829** X Large £17.47  
 • Design allows better dexterity  
 • Reinforced thumb, palm and fingertips

- 11. Irwin General Construction**  
**10503822** Large £20.39  
**10503823** X Large £20.39  
 • Fleece lined breathable fabric  
 • Reinforced thumb, palm and fingertips
- 12. Vitrex Tapered Ear Plugs**  
**303085** 5 pairs £2.21  
 • Disposable foam, shaped for easy insertion  
 • Suitable for most DIY and power tool applications
- 13. Vitrex Safety Goggles**  
**302120** EN166 £4.42  
 • Suitable for woodwork, home renovation, painting and use with most domestic power tools

Also available - please ask...



Ear Defenders

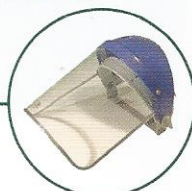

Safety Shield

Brands featured here...



## Combination Auger Bits



**Bahco** - Premium quality bits for the professional

Size	9526 (Std Series)	9527 (Long)
6mm	£8.85	£19.54
8mm	£9.07	£19.81
10mm	£9.07	£20.08
11mm	£9.22	-
12mm	£9.40	£20.31
13mm	£9.70	£20.58
14mm	£10.95	£21.90
16mm	£11.46	£22.93
18mm	£14.31	£26.58
19mm	£14.86	£27.11
20mm	£15.37	£29.96
22mm	£16.68	£31.26
24mm	£17.49	£33.87
25mm	£18.23	£34.92
28mm	£21.63	£37.79
30mm	£23.95	-
32mm	£27.11	£52.10
35mm	-	-
38mm	-	£71.61

**Hardman** - Quality bits economically priced

Size	Code	List Price
6mm	AT31001	£4.44
10mm	AT31003	£4.45
13mm	AT31004	£5.04
16mm	AT31005	£5.92
19mm	AT31006	£7.04
22mm	AT31007	£8.96
25mm	AT31008	£10.24
29mm	AT31008A	£12.72
32mm	AT31009	£14.08
35mm	AT31010	£15.52
38mm	AT31011	£17.28

- Combination Auger Bits for dual powertool and hand brace use
- Precision holes in wood
- Hardened tool steel

## Flat Bits



**Bahco** - Premium quality bits for the professional

Size	9529 (Std Series)	9531 (Long)
6mm	£5.74	£8.07
8mm	£5.86	£8.07
10mm	£6.00	£8.58
12mm	£6.14	£8.58
13mm	£6.27	£9.12
14mm	£6.39	£9.37
16mm	£6.54	£9.37
17mm	£6.65	-
18mm	£6.80	£9.50
19mm	£6.92	£9.64
20mm	£7.05	£9.77
22mm	£7.17	£9.89
24mm	£7.32	£10.40
25mm	£7.45	£10.95
26mm	£7.58	-
28mm	£7.69	£11.21
30mm	£7.81	£11.72
32mm	-	£12.26
35mm	£8.07	£12.78
38mm	£8.31	£13.03
40mm	£8.58	-

**Hardman** - Quality bits economically priced

Size	Code	List Price
6mm	AT32001	£2.00
8mm	AT32002	£2.08
10mm	AT32003	£2.08
13mm	AT32004	£2.15
16mm	AT32005	£2.45
19mm	AT32006	£2.75
22mm	AT32007	£2.95
25mm	AT32008	£3.15
29mm	AT32009	£3.35
32mm	AT32010	£3.65
35mm	AT32011	£3.84
38mm	AT32012	£3.85

- Flat Bits for powertool use
- Superb for fast woodboring

## Hardman Flat & Auger Bit Set

**AT33020** £30.85

- 13 piece set contains:

### Flat Wood Bits

13mm, 16mm, 19mm, 22mm, 25mm & 32mm quick release extension bar

### Auger Bits

10mm, 13mm, 16mm, 19mm, 22mm & 25mm





**1. Stanley Bench Planes**

*Smoothing*

**1-12-004**

No. 4 / 50mm Blade £53.55

**1-12-045**

No. 4 1/2 / 60mm Blade £59.84

*Bench*

**1-12-005**

No. 5 / 50mm Blade £63.75

**1-12-006** £97.55

No. 6 / 60mm Blade £97.55

**1-12-007**

No. 7 / 60mm Blade £111.15

- Professional fully adjustable metal planes

**2. Stanley Adjustable Block Plane**

**1-12-220** 40mm Blade £37.22

- General purpose
- Hardened and tempered tool steel cutter for longer lasting cutting edge
- Fully adjustable for depth of cut and alignment

**3. Stanley Surform Planer File**

**5-21-122** 10" £16.60

- Can be used as plane or file
- Two position swivelling handle
- c/w standard cut blade
- Suitable for all types of 250mm (10") blades

**4. Stanley Surform Block Plane**

**5-21-399** 5 1/2" £8.93

- For use on all types of wood, aluminium, copper, plastics and laminates
- Blade is reversible for bull nose work
- Strong, durable metal body

**5. Stanley Surform Moulded Body Shaver Tool**

**5-21-115** 2 1/2" £2.86

- Ideal for stripping paint and smoothing down filler in awkward places
- Lightweight plastic body

**6. Fatmax Wood Chisels**

**5-16-251** 6mm £10.36

**5-16-253** 10mm £10.64

**5-16-254** 12mm £10.89

**5-16-258** 18mm £11.95

**5-16-261** 25mm £13.48

**5-16-263** 32mm £14.57

- Steel Strikecap – can be used with steel hammer
- Chrome alloy with soft grip handle

*\* Other sizes available*

**7. Hardman Wood Chisels**

**AT27001** 6mm £5.00

**AT27003** 10mm £5.16

**AT27004** 13mm £5.42

**AT27006** 16mm £5.13

**AT27009** 19mm £5.32

**AT27010** 32mm £5.98

**AT27011** 38mm £7.24

- Bevel Edge
- Metal Strike Cap
- Carbon Steel Blades

**8. Stanley Honing Guide Set**

**0-16-050** £15.57

- Consists of sharpening stone, bottle of lubricating oil and a honing guide

**9. Marples Splitproof Chisel Set M373/S6**

£91.93

- Set of 6 splitproof Marples bevel edge chisels
- Chisel sizes - 1/4", 3/8", 1/2", 3/4", 1" and 1.1/4"
- Hardened blade & tempered
- Solid one piece forging with guaranteed unbreakable handles
- Supplied in high quality wooden storage case

**10. Hardman Wood Chisel Set**

**AT27020** 8 piece £31.86

- Comes with honing guide and sharpening stone

Also available - please ask...



Spokeshave



Duplex Rebate Plane

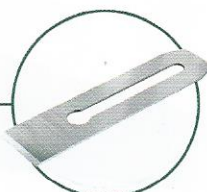

Plane Irons

Brands featured here...



**Hardman**  
WORK TOUGH TOOLS

**Irwin Jack 880 Universal Saw**

88020 20" £10.78  
88022 22" £11.09

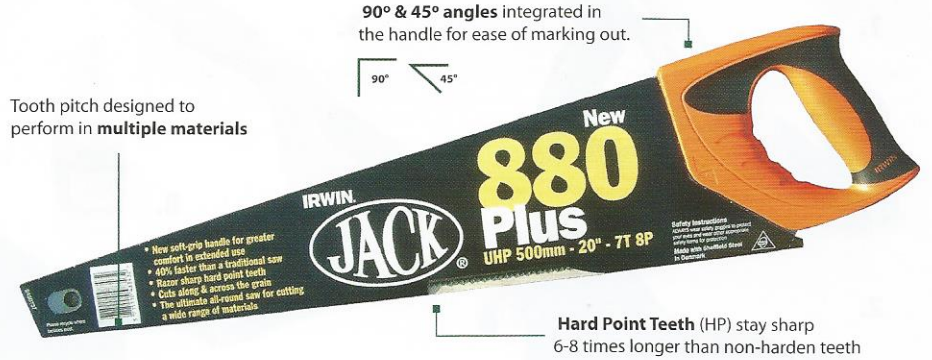

**Bahco 244 Saw**

24420 20" £10.06  
24422 22" £10.52

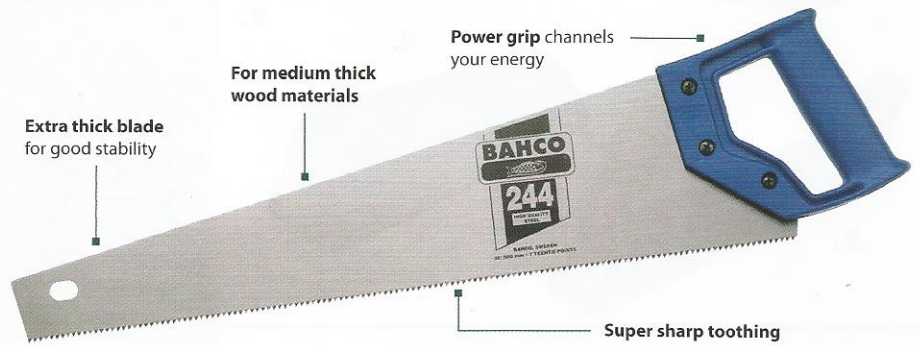

**Stanley Jet Cut Heavy Duty Saw**

5-15-288 20" £13.99  
5-15-289 22" £16.00

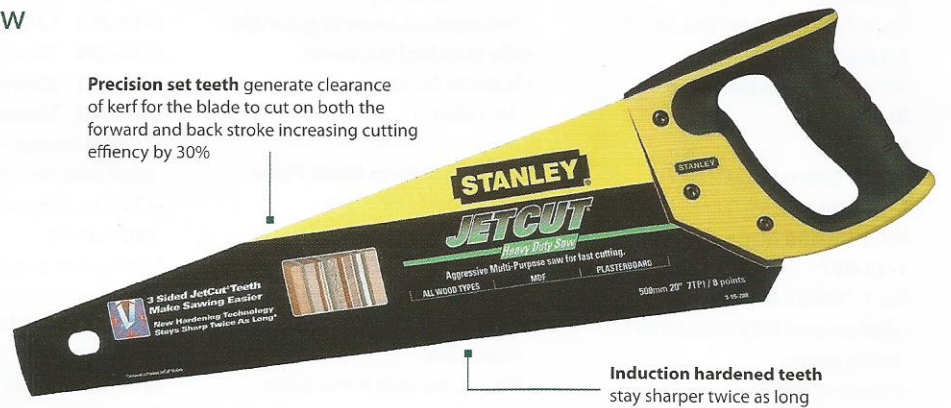

**Hardman Hardpoint Saw**

AT35002 £3.97







**1. Irwin Jack Finecut Saw**  
**990-22** £10.56  
 • High quality steel blade  
 • Cuts on push and pull stroke  
 • Hardpoint teeth for longer life

**2. Bahco Barracuda Saw**  
**Barracuda** £11.88  
 • For medium to thick wood  
 • Extra thick blade for good stability  
 • Two component handle

**3. Stanley Jet Cut Fine Saw**  
**5-15-599** 20" £13.99  
**5-15-244** 22" £-  
 • High quality finish  
 • Bi-material handle  
 • Cuts on push and pull stroke

**4. Spear & Jackson Predator Saw**  
**B98-22** £9.64  
 • A general purpose saw for use along and across grain

**5. Stanley Fatmax Concrete Saw**  
**5-15-441** £17.01  
 • Specially designed 26" blade  
 • Ideal for cutting cellular blocks and soft stone

**6. Bahco Toolbox Saw**  
**300-14** £13.35  
 • Fleam-toothed toolbox saw with very fine hard-point teeth for smooth sawing

**7. Bahco Bowsaw Blades Dry Cutting**  
**51 - 12"** Dry Cutting £4.38  
**51 - 24"** Dry Cutting £6.68  
**51 - 30"** Dry Cutting £7.16  
**51 - 36"** Dry Cutting £7.59  
**Wet Cutting**  
**23 - 21"** Wet Cutting £6.19  
**23 - 24"** Wet Cutting £6.68  
**23 - 30"** Wet Cutting £7.16  
**23 - 36"** Wet Cutting £7.59

**8. Stanley Fatmax Jab Saw**  
**0-20-556** £9.99  
 • Sharpened tip and thicker blade to punch through drywall  
 • Jetcut blade

**9. Hardman Jab Saw**  
**AT35004** £4.65  
 • Triple ground hardened teeth  
 • Two way cutting  
 • Fast cut

**10. Bahco Bow Saw**  
**332 - 21"** £12.89  
 • Professional bowsaw for wood  
 • High quality steel frame  
 • Corrosion & high impact enamel

**11. Irwin Jack Tenon Saw**  
**1360 12"** £9.06  
 • Triple-ground tooth technology  
 • Reinforced back - fine teeth

**12. Spear & Jackson Coping Saw**  
**70CP1R** £11.28  
 • For cutting and Shaping wood  
 • Position blades at any angle

**13. Coping Saw Blades**  
**71-CP7R** £3.83 / 10

Also available - please ask...

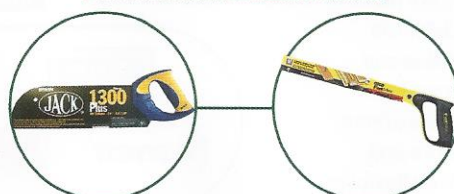

Flooring Saw

Compass Saw

Brands featured here...





14.



15.



16.

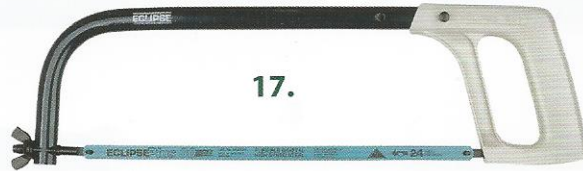

17.



23.



20.



21.



22.

18.

19.



- 14. Hardman Hacksaw AT35005** £7.45
- 300mm (12") Hacksaw
  - High tension blade tightening function
  - Blade can be positioned at 45° and 90°

- 15. Stanley Hacksaw 1-20-110** £19.99
- Fibreglass covered core absorbs more shock
  - Single action blade tensioning

- 16. Irwin Hacksaw 10504407** £19.62
- Ergonomic metal frame for higher blade tension
  - Metal tensioning mechanism

- 17. Eclipse Hacksaw 70-20TR** £19.23
- Tubular steel frame
  - Die cast handle

- 18. Starrett Hacksaw Blades - Blue Stripe**
- 12" x 18 tpi** £216.30 / 100
  - 12" x 24 tpi** £216.30 / 100
  - 12" x 32 tpi** £216.30 / 100
  - Bi-metal high speed steel blades
  - Ideal for tough materials and conditions of all types
  - Tough alloy steel back resists breakage when used under less than ideal conditions
  - Will handle irregular shapes and interrupted cuts with ease

- 19. Bahco Hacksaw Blades**
- £253.80 per 100
  - 12" x 18 tpi** £253.80/100
  - 12" x 24 tpi** £253.80/100
  - 12" x 32 tpi** £253.80/100
  - Virtually unbreakable and shatterproof bi-metal
  - Sandflex combines extreme cutting performance and wear resistance with flexibility

- 20. Hardman Junior Hacksaw AT34001** £1.10
- Powder coated steel frame
  - Fitted quality rubber finger guard
  - Supplied with 32 tpi blade for metal and 14 tpi for wood

- Replacement Blades AT34002** Metal 32tpi £1.10
- Pack of 10 replacement blades

- 21. Spear & Jackson Junior Hacksaw 70-14JR** £3.38
- Epoxy coated steel frame with eclipse blade
  - For general cutting applications

- 22. Spear & Jackson Mini Saw 70-675R** £10.46
- Plastic moulded pistol grip handle with blade tensioning device
  - Steel frame with eclipse blade

- 23. Nobex Champion Mitre Saw 6603T808055B** £92.00
- Large capacities - up to 180mm in depth and 125mm at 45°
  - Indexable mitre angle setting
  - Grooves on table surface for cutting compound angles
  - Fast action work clamp
  - Repeat length stop
  - Adjustable depth stop
  - c/w rear fence extender

Brands featured here...



IRWIN



Starrett

BAHCO

NOBEX

SPEAR &amp; JACKSON